

Daily Record

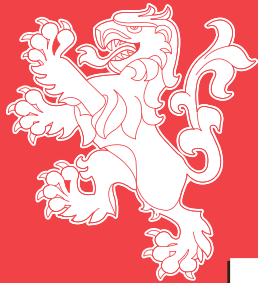

SCOTLAND'S CHAMPION

95p

CHELTENHAM FESTIVAL DAY 2

GET YOUR UNMISSABLE 12-PAGE PULLOUT



STURGEON
Face mask rules still in force until April

PAGES 12&13

FREE £2

SHOP BET WITH



INSIDE TODAY
VALID ON ANY SPORT

18+ TERMS APPLY DETAILS ON PAGE 10 OF PUNTER PULLOUT

TAKE TIME TO THINK



EXCLUSIVE

I'LL FIGHT TO THE DEATH TO DEFEAT PUTIN



ARMED & READY
Adam has joined fight against Ukraine's Russian invaders

A SCOTS garage owner has joined the foreign legion defending Ukraine.

Adam Ennis is part of an international platoon embedded in the capital Kyiv as it is surrounded by Russian troops.

The 35-year-old, who has no

BY MARK MCGIVERN

military experience, has vowed to stay "until Putin is defeated".

He also told how he was lucky to leave a base near the Polish border shortly before it was destroyed by 30 cruise missiles.

PAGES 4,5,6,7,8,9,10&11

» Scots garage owner with no military experience joins forces defending Kyiv

» Adam, 35, tells how he was lucky to leave border base before missiles hit

INFO

ONLINE AND ON MOBILE

WWW.DAILYRECORD.CO.UK

facebook.com/TheScottishDailyRecord
twitter.com/Daily_Record

TODAY'S WEATHER

Glasgow & West

The chance of a shower but some spells of sunshine too. Max 10C (50F). Winds NW at 8-10mph. UV index: 2.

Edinburgh, Fife & Borders

There will be scattered showers with a lot of cloud too. Max 9C (48F). Winds NW at 8-10mph. UV index: 1.

Dundee & Aberdeen

Dull with cloudy skies and scattered light showers. Max 7C (45F). Winds NW at 4-6mph. UV index: 1.

Forth Valley

A lot of cloud cover around and some scattered showers. Max 8C (46F). Winds W at 5-7mph. UV index: 1.

Inverness & Moray

Dry with sunny spells. Max 9C (48F). Winds SW at 6-8mph. UV index: 2.

Highlands & Islands

Bright with sunny spells and heavy showers. Max 9C (48F). Winds SW at 13-15mph. UV index: 2.

SUN, MOON & TIDES

Moon sets: 6.39am

Moon rises: 3.53pm

Sun sets: 6.22pm

Sun rises: 6.27am

Lighting-up time: 6.22pm

High water:

Greenock 11.24am

Aberdeen 12.23am, 12.29pm

Leith 1.35am, 1.50pm

AIR QUALITY

Highlands: 3 Central: 3
North East: 3 Borders: 3
Low (1) Very high (10) uk-air.defra.gov.uk

7-DAY FORECAST

UK Weather
www.metoffice.gov.uk

TRAVEL ADVICE

Calls cost 60p per minute

AA ROADWATCH: 09003 401161

EUROMILLIONS

M. Maker: JPBB50608
Est jackpot: £33million

1 2 12 19 26 2 8

THUNDERBALL 16 18 23 26 30 3

EMERGENCY HELPLINES

NHS 24	111
National Rail inquiries	0345 748 4950
Scottish Hydro Electric	0800 300 999
SP Networks	0800 092 9290
Scottish Water	0845 601 8855
Gas emergencies	0800 111 999
Childline	0800 1111
Crimestoppers	0800 555111
Samaritans	116 123
Victim Support	0345 603 9213
Scottish Domestic Abuse helpline	0800 027 1234
Scottish SPCA	03000 999 999

LOOKING FOR A JOB? THOUSANDS OF VACANCIES AT FISH4.CO.UK

CORRECTIONS AND COMPLAINTS

If we have published anything factually inaccurate, please contact the readers' editor on 0141 309 3454, by email at readerseditor@dailyrecord.co.uk or write to Readers' Editor, 1 Central Quay, Glasgow, G3 8DA and, once verified, we will correct it as soon as possible.

The Daily Record is published by Media Scotland, a subsidiary company of Reach PLC, which is a member of IPSO,



the Independent Press Standards Organisation. We adhere to the Editors' Code Of Practice as enforced by IPSO, which is contactable for advice at IPSO, Gate House, 1 Farringdon Street London EC4M 7LG
Website www.ipso.co.uk
Telephone: 0300 123 2220,
email advice@ipso.co.uk

If you have a complaint concerning a potential breach of the Code of Practice, we will deal with your complaint directly or IPSO can refer your complaint to us. Please go to www.reachplc.com/how-to-complain where you can view our Complaints Policy and Procedure. A How To Complain pack is also available by writing to the Legal and Compliance Department, Reach PLC, One Canada Square, London E14 5AP.

PHONE 0141 309 3251
EMAIL reporters@dailyrecord.co.uk

Protect YOUR home from Care Fees

Don't lose your home if you end up in care



Freephone
0800 049 9688
www.ilawsscotland.co.uk

Kids in mental health crisis face longer wait times

BY VIVIANNE AITKEN
Health Editor

CHILDREN in desperate need of mental health support are having to wait even longer to be seen. Last night there were demands for a "radical transformation" of mental health services after new figures showed services in crisis.

The latest Public Health Scotland (PHS) figures for Children and Adolescent Mental Health Services (CAMHS) show three in every 10 children waited more than the targeted 18 weeks to be seen.

Shockingly, the figures show more than 1500 children had waited more than a year for treatment to begin. There was also a huge spike in referrals up more than 2000 from the previous quarter.

A spokesperson for the Scottish Children's Services Coalition said: "For some time now, we have raised concerns over a potential lost generation of vulnerable children and young people, whose mental health is being impacted even further by the Covid-19 pandemic.

"There must be a radical transformation of our mental health services, investing in specialist services and with a focus on preventing such problems arising in the first place and intervening early."

Minister for Mental Health Kevin Stewart said the figures showed "a record number" of children and young people starting treatment, with more than 4500 receiving first appointments.

He said: "Long waits for treatment are unacceptable and we remain committed to meet the standard that 90 per cent of patients begin treatment within 18 weeks of referral."



AFRAID
Kyle and parents
Kirsty and Scott

KYLE'S STORY

LITTLE Kyle Solman has tried to end his own life three times since November.

The 10-year-old has told doctors: "I just don't want to be here any more, I've had enough."

But his parents Kirsty and Scott say his actions have been dismissed as a "phase".

The couple have been forced to take turns sleeping because they are so afraid

Kyle will try again. The family, of Glasgow's Drumchapel, have started a petition calling on the Scottish Government to do more for children with mental health issues.

Kirsty, 39, said: "At the moment a health professional makes an electronic referral and CAMHS makes their decision based on that. That is not

an adequate referral process. If a health professional has made a referral surely that warrants a child being seen.

"If they are not seen, that child will still be struggling."

Kirsty, a nurse, added: "We are failing these children and if they are not seen they could end up in A&E like my son did, aged 10 and trying to end his own life."

'HUGE RELIEF FOR DISABLED PEOPLE'

EXCLUSIVE
BY PAUL HUTCHEON

DISABLED people with the most serious lifelong health conditions will not have to go through stressful reviews when they get a new Scottish Government-run benefit.

Vulnerable Scots will be eligible for an "indefinite award" under the Adult Disability Payment (ADP), which will be piloted this month.

ADP will replace the UK Government's Personal Independence Payment (PIP) following the devolution of parts of the social security system. Working age disabled people, those with a long-term health condition and people who have a terminal illness will be able to apply.

Long-term awards are granted in some circumstances to PIP claimants but they can be reviewed on a regular basis.

Under ADP, disabled people on the highest level of the new benefit and whose needs are highly unlikely to change will not be subject to review.

People with cerebral palsy, dementia and cystic fibrosis could be among those eligible.

Social Security Minister Ben Macpherson said: "We want to

New disability benefit will end stressful reviews for lifelong sick

Scots will soon be eligible for 'indefinite award'

ensure that people on the highest levels of Adult Disability Payment awards receive long-term and adequate support, because those with lifelong conditions, or disabilities resulting in needs highly unlikely to change, should not be subject to unnecessary reviews

when it is reasonably expected that their situation will not change... we are determined to do things differently and build a more compassionate system in Scotland."

Moirra Tasker, Chief Officer at Inclusion Scotland, welcomed ADP and said: "It will come as a huge relief for disabled people with high, permanent levels of impairment who faced

continual reassessments under the flawed DWP PIP system. Indefinite awards will also provide some certainty and security for those who receive them."

Labour MSP Pam Duncan-Glancy said: "This is a welcome announcement, and I look forward to hearing more detail in the weeks ahead from the Scottish Government."



SUPPORT
Macpherson

CELEBRITIES GIVE IT PELTERS AT CHELTENERS

TROT LEGS



NOVICE ERROR McCoist

Ally has a mare in search for his Airbnb

ALLY McCOIST was quizzed by cops after getting lost trying to find his accommodation for the Cheltenham Festival.

The Rangers great went to the wrong house on Monday and caused a stir when he looked into someone's home while searching for his Airbnb cottage in the Costwolds town Chipping Campden.

McCoist, 59, said: "My wife sent me directions but a taxi driver couldn't find the street.

"I was staying in No1 in a street and thought, 'No2 must be right next to it'. I looked through a window and could see a woman's handbag and a hat inside.

"I knocked on the door but nobody answered. Then I heard someone say, 'Can I help you?' I turned round and there's a cop standing there.

"I said I was looking for No2 and he said, 'Oh, you won't find it in there, sir'.

"So I got escorted, very kindly, by this police officer to my address. It could only happen to me."

On day one of the festival, a steward wouldn't let him in the racecourse. McCoist added: "I thought my face was my ticket but seemingly it's not at the Cheltenham Festival."

YOU WEAR IT WELL Rod Stewart at Cheltenham. Below left, a racegoer in a feathered hat. Main Pic: James Whatling



CARRY OUT Rod's strong wife Penny Lancaster picks up former jockey Frankie Dettori. Left, Rod snuggles in to Penny on a chilly day at the races

Rod, Penny and Frankie horse around as Scots shine on day one of festival

RACING legend Frankie Dettori wasn't the only one to get a lift at Cheltenham yesterday.

Rod Stewart's wife, Penny Lancaster, swept the three-times Champion Jockey off his feet on a day that saw a trio of successes for Scottish racing.

The main race of the day - The Champion Hurdle - was won by Honeytrap, owned by Ayrshire-born business tycoon Kenny Alexander.

Meanwhile, Edwardstone, trained by Lanarkshire-born Alan King, won the Arkle and Corach Rambler, trained by Lucinda Russell,

BY RECORD REPORTER

from Milnathort in Kinross-shire, won the Ultima.

Huge crowds lapped up the excitement on a packed opening day - a dramatic contrast from the empty stands at last year's Covid-hit event.

Among racegoers were dapper rocker Rod and Penny, who attracted attention with their colour-coordinated outfits.

Rod, 77, looked the part in a camel-coloured coat, silk waistcoat and cream trousers.

Penny, 51, turned heads in brown cords, tan leather boots and a tweed jacket.

She topped off her look with a silk scarf and shades perched on top of her head.

No Cheltenham Festival would be complete without the royals and Zara and Mike Tindall made quite the entrance.

Mum-of-three Zara looked striking in a plum-coloured cape, bag and matching hat.

Former England rugby star Mike chatted away with his sports pals in a checked blazer, navy trousers and matching tie.

With champagne and super schmoozing opportunities it's no wonder stars can't resist the festival.



2021

EMPTY Crowds were not allowed last year due to pandemic



2022

FULL Stands were packed with racegoers yesterday



WINNERS' ENCLOSURE Racing fans

12-PAGE PUNTER SPECIAL INSIDE

WAR IN UKRAINE: KYIV SCOT



DAY JOB
Adam at work in his garage in Biggar

A SCOTS garage owner with no military experience has joined the foreign legion defending Kyiv from Russian attack.

Adam Ennis, from Biggar, Lanarkshire, has signed up for an international platoon that is now embedded in the Ukrainian capital as it is encircled by Russian troops.

The 35-year-old spoke to the Record from his position in the city – and revealed he escaped death after leaving for Kyiv from a base near the Polish border shortly before it was destroyed by Russian bombs.

Cruise missiles hit the base at Yavoriv. It's believed at least three British special forces soldiers were among more than 100 dead.

Adam, who owns Big B's Garage in Biggar, has been on daily patrols and has seen active combat, firing on Russian soldiers.

Kitted out in army uniform and holding a Russian PKM machine gun and a Czech-made Skorpion pistol, he said: "The city will soon be totally encircled but I am here until Putin is defeated. There is a serious chance I will be killed but I made the decision to come as a matter of conscience.

"I came here to protect the innocent and to help them in a battle against evil. If Putin was not met with strong resistance here this could snowball into something much larger and has the potential to be the start of World War III and could be a threat to us all.

"Morale is good with both us international boys and the Ukrainian people. We are united and committed to the cause. It's heartbreaking some of the things I have seen – I have lost friends but I am happy with my choice to be part of this fight against tyranny."

Adam's extraordinary and terrifying mission was launched 13 days ago, when he boarded a £40 one-way flight

EXCLUSIVE
BY MARK MCGIVERN

from Edinburgh to Krakow with just a gym bag on his shoulder.

Consulate staff there advised him that information on volunteer and mercenary forces was being distributed from Warsaw.

After travelling to the British Embassy there, he was put in touch with the Ukrainian military, who directed him to a base at the Poland/Ukraine border. He then moved on to the base near Lviv that was bombed on Saturday with massive loss of life.

Adam said he was stationed with the newly formed Ukrainian Foreign Legion at the International Peacekeeping and Security Centre near Lviv before being picked, along with 15 others, for a separate platoon.

That unit, commanded by a special forces officer, was sent to Kyiv. He revealed that men he had befriended were among those killed on Saturday after the strikes on Starychi, near Lviv.

He said: "Russia claimed they killed 180 mercenaries and I believe they are telling the truth this time. If I hadn't been moved to Kyiv, I would be dead."

Adam said that his platoon is well equipped and professionally

organised.

He said: "The foreign legion was being quickly thrown together and wasn't that well organised. I had spoken with some other men of making our way to Kyiv ourselves to join a militia.

"But, as it happened, myself and 14 others were picked for another unit and this one is a different story, really quite professional and well organised with special forces officers running it."

When the Record spoke to Adam, he was preparing for a specific attack, with four platoons, on a Russian unit that has dug in close to their position.

The troops are armed with Stinger anti-aircraft missiles and the latest

I know there is a serious chance that I'll be killed but I'm here until Putin is defeated

Garage boss joins up after YouTube arms training

Javelin anti-tank weapons, seen as highly effective in urban warfare. He said: "I can't say anything specific on what we're doing or where we are.

"There are four platoons of around 50 men each, almost all experienced and well-trained soldiers.

"Some of the Ukrainians have phoned family members in Russia and they have a wildly distorted view of what is going on here.

"You can feel the morale draining out of Russian soldiers as they learn the reality of their invasion.

"That is the opposite of what is going on with Ukrainian soldiers, who are prepared to die for their country.

"It has been humbling to meet Ukrainians who realise I've come from

Scotland to join them. It has been pretty emotional."

Adam is stationed in the basement of a Kyiv restaurant, sleeping on a yoga mat and sleeping bag.

He said: "It gets very cold at night but we have proper equipment. This isn't playing around, as all the men here are professional soldiers except me. I have seen some pretty terrible sights already.

"I have comrades from England, Sweden, Georgia, Brazil, Kazakhstan – a real international corps."

The foreign legion soldiers have been offered £400 a month for their services. Adam said: "The money is neither here nor there for me. I'm here for the duration and I'm not actually sure how

much they want to pay or how they might pay it. I came here as a volunteer, not a mercenary."

He carries a pack weighing up to 40kg, containing his machine gun and five boxes of ammunition.

He said: "I was given some training at the firing range near Lviv and, after that, the platoon leader picked out 15 men he liked the look of.

"I did look up a YouTube video on how to assemble and disassemble a Russian PKM machine gun."

Adam has never done military service. His only experience was at Merchiston Castle School in Edinburgh, where he was in a Combined Cadet Force, which covered drill, first-aid, target shooting and fieldcraft.

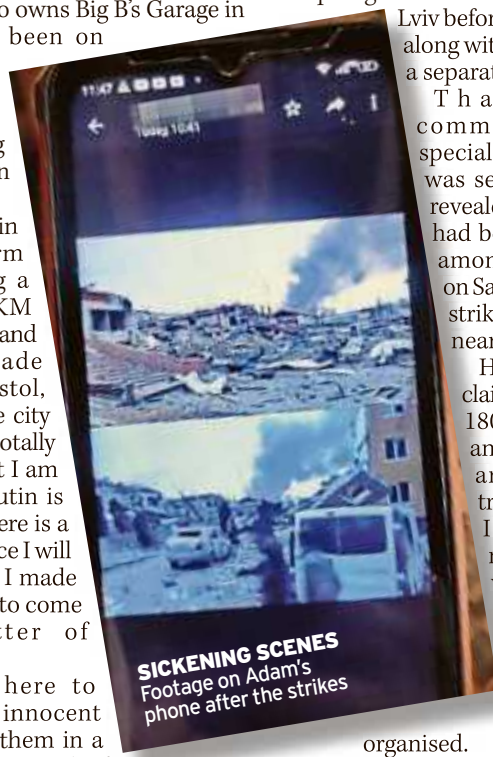

IN SECRET ARMY MISSION

FIRING RANGE
Adam had no basic training but is now armed to fight Russian forces

DEFENDING CAPITAL
Adam arrived in Kyiv to see off Russian attempts to take the city



TERROR A woman is evacuated from a burning apartment block in Kyiv

KYIV BURNING AS RUSSIANS STEP UP ONSLAUGHT

RUSSIAN forces blasted Kyiv relentlessly yesterday killing civilians as air raid sirens blared across Ukraine. Thundering artillery pounded the capital as it emerged Russia has now lost 13,500 troops in the invasion.

by **CHRIS HUGHES**
in Ivano-Frankivsk, western Ukraine
Pictures: **ROWAN GRIFFITHS**

destruction. Just two per cent believe Putin is trying to protect Russian speakers, according to social study organisation Rating Group.

Air-raid sirens even blared in the west in cities such as Ivano-Frankivsk, where the airport has been blitzed three times in the past 20 days.

Police there have warned locals to look out for strangers, as they could be Russian spies.

Sources say intelligence agency SBU's local office believes agents rented apartments there months before the invasion.

It is believed they have provided intelligence on long-range missile targets.

Ivano-Frankivsk is a supply hub, sending vital medication, clothing, military fatigues and even bedding to frontline troops. It has provided as many as 150 volunteer soldiers to the frontline in Kyiv.

Across Ukraine, a second wave of troops is being called upon to fight in the capital as it desperately hangs on.

The shelling ignited a huge fire in a 15-storey apartment building and spurred a frantic rescue effort. Two people were killed when Russia struck an aircraft factory in Kyiv. The Antonov factory produces many of the world's biggest cargo planes.

A town councillor for Brovary, east of Kyiv, was killed in fighting and shells fell on the suburbs of Irpin, Bucha and Hostomel. Nine people died in a rocket attack on a TV tower in the western town of Antopol and, in the eastern city of Kharkiv, a four-storey residential building was destroyed.

But Moscow has also suffered massive casualties. As well as 13,500 dead, its forces have lost 81 warplanes, 95 helicopters, 404 tanks and four generals in 20 days, it was revealed yesterday.

Heartbreaking figures emerged of at least four children a day being killed by Russian shelling - more than 90 in total. More than 100 children have been injured since the invasion and Moscow's forces have blitzed 400 schools, destroying 59 of them.

But Zelensky vowed: "Russia has already begun to understand they will not achieve anything by war."

ACTION HERO In Army uniform ready to take on Russians



“

I looked up a YouTube video on how to assemble and disassemble a Russian PKM

ADAM ENNIS BIGGAR GARAGE BOSS NOW FIGHTING PUTIN

RECORD VIEW

A welcome fall in drug deaths

SCOTLAND needed some good news on drug deaths.

Today's finding – that the toll for 2021 was eight per cent down on 2020 – is welcome. But we know it's not good enough.

The reduction takes us back to the levels of 2019, which were scandalously high. But at least the numbers are now falling, so it is a step in the right direction.

The Daily Record has condemned the Scottish Government's performance on drugs over the years.

We have not been merely carping from the sidelines.

We have observed how our leaders have failed to connect with those who battle addiction. And we've witnessed years of painfully laboured lip service.

Yet there are some distinct glimmers of hope to emerge in the last 18 months.

Our campaigning relentlessly demanded more cash to fund treatment programmes and moves away from the punitive persecution in courts of people who are in addiction.

And we must now give credit where it's due – because the Scottish Government has made strong moves in both areas.

First Minister Nicola Sturgeon's "national mission" on drugs puts up £250million over five years. And Lord Advocate Dorothy Bain's recent bold statement on drugs prosecuting guidance in the Scottish Parliament was very much in line with our pleas for the decriminalisation of drug possession.

We now have to ensure that every penny of the drugs war chest is properly spent.

Scotland deserves value for money and a guarantee that we are investing in methods that work.

CAUTIOUS HOPE – PAGE 17

Benefits boost

SUCCESSIVE Tory governments have treated vulnerable people on benefits shamefully.

They maligned claimants as scroungers and burdens on the state.

Former prime minister David Cameron cruelly froze the value of payments, while current PM Boris Johnson went a step further by reversing the £20-a-week rise in Universal Credit.

Tory Ministers also forced people to jump through hoops for the measly scraps they served up.

The devolution of some benefits provided the Scottish Parliament with a chance to do something different.

So, it is heartening that some people who will claim the new Adult Disability Payment (ADP) will be given "indefinite" awards.

They will no longer have to wait anxiously to see if there will be a "review" to determine their eligibility.

Compassion, not judgement, should be the hallmark of the system.

The ADP move is a small step in the right direction, but welcome nonetheless.

INDEFINITE AWARDS – PAGE 2

WAR IN UKRAINE: YOUNG



SAFETY FIRST Nurses take babies to basement as air-raid sirens sound

BY **AMY SHARPE** in Korczowa and **RACHEL WEARMOUTH**

FRIGHTENED and anxious, a group of pregnant women are led into a dark hospital basement as air-raid sirens ring out above ground.

Since the start of the war, dozens of babies have been born underneath the maternity hospital in the southern city of Mykolaiv, where violence has been escalating.

Yesterday's grim scene played out as figures from global children's charity Unicef showed that almost one child a second has been made a refugee since Russia's brutal invasion began 20 days ago.

More than 1.5million kids, over 73,000 a day, have fled Ukraine.

President Volodymyr Zelensky said 97 children had been reported dead in the invasion and UNICEF's James Elder said: "Many more have been injured."

The UN said the total number of refugees has passed 3million, with more than half crossing into Poland.

Among them is Ivanna Burka, who said she had "no choice" if she wanted to protect her child.

Just 10 weeks ago, Ivanna was on holiday in the Carpathian mountains with husband Volodymyr, 28, and eight-year-old son, Roman, to celebrate the new year.

Now Volodymyr is fighting for their country in Luhansk, eastern Ukraine, and Ivanna and Roman fled after Russian air strikes hit an Army base near her home in Yavoriv on Sunday.

Speaking hours after her group crossed the border into Korczowa, south east Poland, she said: "We did not want to leave but we have children and I am afraid for them. "I was scared. I heard rockets, explosions. I hid in the basement with my son. We are in danger in Ukraine. I can't sleep at home."

The mum smiled as she showed us photos of her recent holiday with Volodymyr: "We were outside together and so happy.

"We did not know he would have to leave us to fight so soon."

The joyful pictures were in stark contrast to a grim selfie of him in military kit weeks later.

"I'm afraid for him," Ivanna said. "Roman is missing his father. He is brave and strong but I want to get him a cat or a dog to help him. We

The war

» Infants born in dark basement as air-raid sirens sound

» Almost one child a second is fleeing Putin bombardment



SCARED Mother-to-be and her husband shelter in the maternity hospital's basement to wait for their baby - as Mykolaiv awaits a siege



speak to my husband every day." Ivanna fled with a group which included her sister Iryna Shylo, 27, and one-year-old niece, Veronika.

Yesterday they had an emotional reunion with family friend Adam in Korczowa before setting off on a 700km journey to Zielona Gora, near the German border.

Another refugee, Maria Shiakhova, an engineering teacher, has continued to hold lessons while travelling thousands of kilometres from Kharkiv, where a bomb smashed the doors and windows of her home.

She said "terrible things" have happened

in the city but she wants to help "build the future Ukraine" by teaching her students remotely.

The 24-year-old mum said: "We all continue our work. We must work for our country's future."

She has held classes over Skype as she travels to Warsaw with her son, Lev, four, and plans to complete her postgraduate disser-

tation in Poland. She said: "I am helping five students with Skype. I call them and together we write. In May they will take their exams."

"Some are in Germany, Poland and some are in Ukraine, in areas that are more secure."

Her colleagues at Kharkiv National University are teaching their students from a bunker after shelling in the city intensified.

Holding back tears, Maria said: "A bomb went off near my house and the glass and doors smashed. My university was on fire. I had no choice, I had to go. I was in another part of

“

A bomb went off near my house. My uni was on fire. I had no choice.. I had to go

REFUGEE MUM OF ONE **MARIA SHIAKHOVA**

BEAR BRUNT OF RUSSIA INVASION

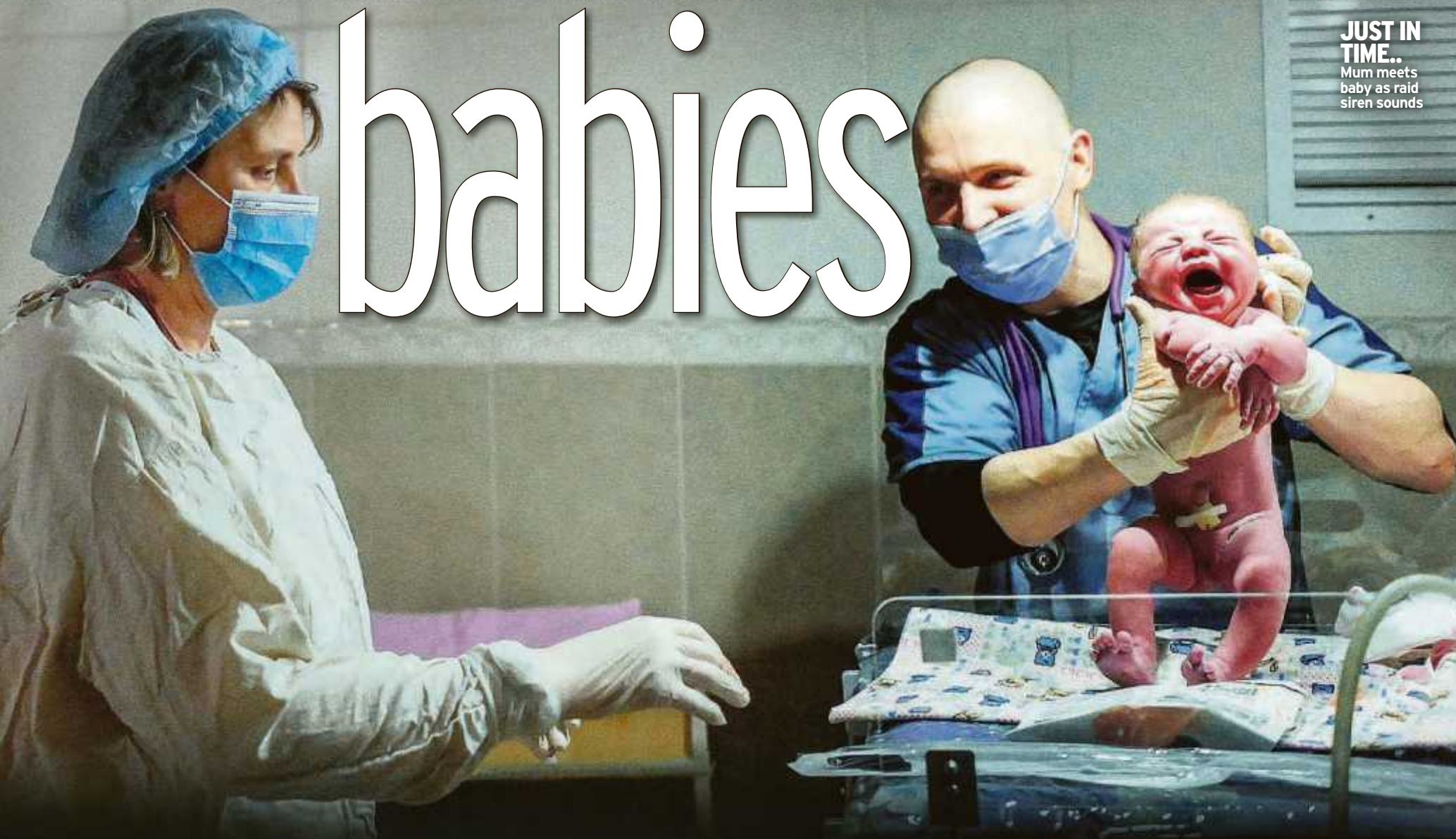

JUST IN TIME..
Mum meets baby as raid siren sounds

babies



DARK Pregnant women below Mykolaiv hospital



CUDDLE Mother and infant try to find comfort underground

town with my parents. Now they live underground in a train station, where there is a good cellar. They have been there seven days. My parents in Ukraine are strong. It's their home."

Her husband of five years Mazk, 24, an engineer, also remained in the country, helping to source and build materials for the war effort.

"He works because we must continue to work, for our Ukraine's future," said Maria, who hopes to return in time for his 25th birthday on June 1. She vowed: "I will go home, I want to go home."

About 29,000 people were evacuated from Ukrainian cities through humanitarian corridors yesterday, most of them leaving the besieged port of Mariupol, a senior government official said.

Some seven per cent of Ukraine's population have become refugees. Last night, more than 120,000

people in the UK had signed up to host a refugee at their home, within hours of a Government site going live. PM Boris Johnson praised the "fantastic" response to the Homes For Ukraine scheme.

Hosts will be offered £350 a month and are asked to sign up for a minimum of six months, though Ukrainians will be eligible to stay in the UK for three years.

But concerns were raised about vetting of sponsors and support available for new arrivals, with one group warning of a "real risk" some refugees could be left homeless.

The Home Office said the total number of visas it had issued, as of 4pm on Monday, was 4600.

According to its website, 17,600 applications had been submitted with 10,900 appointments made at visa processing centres.

The Refugee Council called for the Government to waive visa

restrictions, arguing they would be complex and restricted to refugees known to people in the UK.

Chief executive Enver Soloman said: "A humanitarian crisis requires a speedy and compassionate response, not one that puts bureaucratic hurdles ahead of the immediate needs of people whose lives have been ripped apart."

Enver said he was worried about ensuring the safety of "very traumatised" women and children fleeing bloodshed and the support available for their sponsors.

He called for refugees to get full access to benefits, GPs, mental health services and schools.

Shadow Communities Secretary Lisa Nandy praised the public's "heartening" offers to help. But in a letter to Cabinet Minister Michael Gove, she said the Government should be more actively involved in matching refugees with sponsors.

Cancer children are 'doing well'

THE 21 child cancer patients evacuated from Ukraine are doing well after arriving at seven NHS children's hospitals.

The youngsters had endured a journey across the war-torn country to Poland before being flown to England on Sunday.

Medics from Southampton Children's Hospital and Birmingham Women's and Children's Hospital accompanied the children and their guardians.

Birmingham oncologist Dr Martin English said: "The children are all safe and doing as well as expected, especially after all the trauma they have endured."

Terrified teen's text of thanks

A FRIGHTENED 14-year-old Ukrainian sent a WhatsApp message to a British family to say: "Thank you for giving us an opportunity to live in a safe country".

Victoria Malona, mum Lillia, 38, dad Vitalii and sister Ilona, six, are expected to arrive in the UK next week.

Sabrina and Tony Edge offered them space at their home in Driffield, Yorkshire, alongside daughters Emily, 19, Maddie, 16, and Kitty, 11. Sabrina said the message made her family "sad".

Now in Moldova, the Malonas can still hear bombs falling a mile away in Ukraine.

Home scheme may be fast-tracked

NICOLA Sturgeon says people in Scotland should be able to welcome Ukrainian refugees into their homes "very soon".

The First Minister is confident proposals for the Scottish and Welsh governments to act as "super-sponsors" of 3000 Ukraine refugees will get the go-ahead.

Sturgeon yesterday told MSPs: "The UK Government has indicated support for this proposal in principle and has committed to working

BY **TORCUIL CRICHTON**

with us towards its immediate launch alongside the wider UK scheme. I hope that it will allow Scotland to welcome 3000 Ukrainians to Scotland very soon."

Sturgeon and Welsh first minister Mark Drakeford propose to bypass the UK's "Homes for Ukraine" scheme by accepting 3000 refugees each without first linking them to UK hosts offering accommodation.

Sturgeon added: "Under the UK scheme it may be

some time before most of those offering help will be able to actually welcome someone from Ukraine. The Scottish Government's 'super-sponsor' proposal is intended to short-circuit this and allow Ukrainians to get here and be supported more quickly."

Refugees would be put in temporary accommodation in Scotland and Wales before linking them to host families. Each household taking a refugee will be offered £350 a month.

WAR IN UKRAINE: TRUTH

Sea creatures and lies: How Russia tries to twist reality

BY **GABRIEL GAVIN**
Moscow-based British journalist

FOR weeks, ordinary Russians have been bombarded with TV reports designed to convince them that the "special operation" in Ukraine is both going well and morally justified. Here's what we saw during a day's viewing...

BREAKFAST TV: MORNING IN RUSSIA

Viewers switching on their TVs from 5am are greeted with scenes of apparent devastation broadcast on one of the country's most popular TV channels. But the carnage wasn't in Ukrainian cities besieged by Russian troops.

In one clip, locals in Donetsk, held since 2014 by pro-Moscow rebels, lay flowers after civilians were reportedly killed "by Ukrainian aggression" in a missile attack. One local woman tells the camera crew, "it's scary, this is the centre of the city, it's supposed to be the safest place".

Western governments and international observers are yet to verify the incident.

LIVE NEWS: RUSSIA 24

The country's go-to station for rolling news, Russia 24 plays on screens everywhere.

Today it leads its lunchtime slot with a live broadcast from a press conference with General Igor Kirillov, the head of Russia's

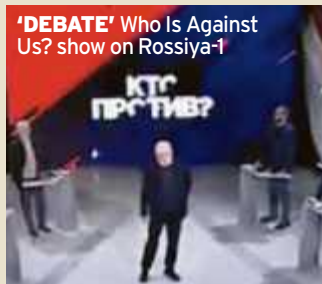

radiological, chemical and biological warfare unit.

The top officer claims Ukraine has "30 biological laboratories" set up by the US in a secret weapons programme, which he insists is a threat to Russians.

WHO IS AGAINST US? ROSSIYA-1

On Who Is Against Us?, an afternoon show on the Kremlin's flagship current affairs outlet, Rossiya-1, a "debate" is held between commentators in which they attempt to take apart the arguments against Putin's war.

According to the host, veteran media personality Dmitry Kulikov, the key question is whether Ukrainian President Volodymyr Zelensky is "good enough" to be allowed to remain in power.

Featuring footage from the scene of a supposed rocket strike in Donetsk, guests one by one condemn Kyiv's leader as a "dictator" and a "madman."

ROLLING NEWS: ROSSIYA-1

Throughout the day, producers at the news channel flash up clips of Russian jets taking out what they describe as Ukrainian military targets.

One graphic repeatedly shown to viewers indicates that the war is going in Moscow's favour, insisting 156 Ukrainian aircraft and pieces of aviation equipment plus 1306 tanks and other armour have been destroyed.

No mention is made of the country's own losses.

FACTS: RUSSIA 24

A primetime evening show designed to rebut criticism of government policy, on Tuesday night Facts aired footage of rallies in support of Putin's war - half a dozen demonstrators flying Russian flags and those of Ukraine's breakaway republics.

NAVY SEALS: RUPTLY

Ruptly, Russia's international news network, based in Berlin, on Monday published a video report on the country's "navy seals" - two of the marine mammals dressed in army berets and pirouetting with fake rifles.

Director of Baikal Aquarium Evgeniy Baranov told Ruptly TV: "The seals were intended to provoke some patriotic feelings."

“It was my anti-war decision. I don't like Russia starting this invasion. It was really terrible

MARINA OVSYANNIKOVA ON HER LIVE TV NEWS PROTEST



SIGN OF THE TIMES
Marina with banner on live TV news show

ROMAN ON RUN

He's in Moscow as more cronies hit

BY **JEREMY ARMSTRONG** and **PIPPA CRERAR**

TROUBLED tycoon Roman Abramovich arrived in Russia yesterday as he moved to protect his £12billion cash and assets around the globe.

The Chelsea owner's private jets and two yachts worth more than £1billion were safeguarded before yet more UK and EU sanctions were put in place.

Abramovich looked dishevelled as his £49million Gulfstream G650 LX-RAY jet left Israel after the country made it clear they would not become a "safe haven" for sanctioned Russians. Air-tracking services showed it then travelled to Istanbul.

Sources confirmed he was on board yesterday as it landed in Moscow.

Two of his yachts, £445million Solaris and £537million Eclipse, were also thought to be heading for "safe" Turkish waters.

The move came as hundreds of powerful Russians linked to the Kremlin were hit by tough sanctions. Just hours after a new law cleared in Parliament, the



WAIT Abramovich in Israel

UK announced 370 new targets, and froze the assets of Abramovich.

But he reportedly "exercised effective control" of Evraz, a steelmaker which "potentially supplies steel" for Russian tanks.

His stake is worth £420million. His shareholding was moved eight days before

Russian president Vladimir Putin ordered the invasion of Ukraine. Abramovich was

THE ALLY Dmitry Medvedev

Served as Russian president from 2008-12 and PM from 2012-20, swapping roles with Putin until he was able to alter the constitution to stay in the top job. One of Putin's closest allies. Deputy chairman of the Security Council.



WILL OUT... NO HIDING PLACE

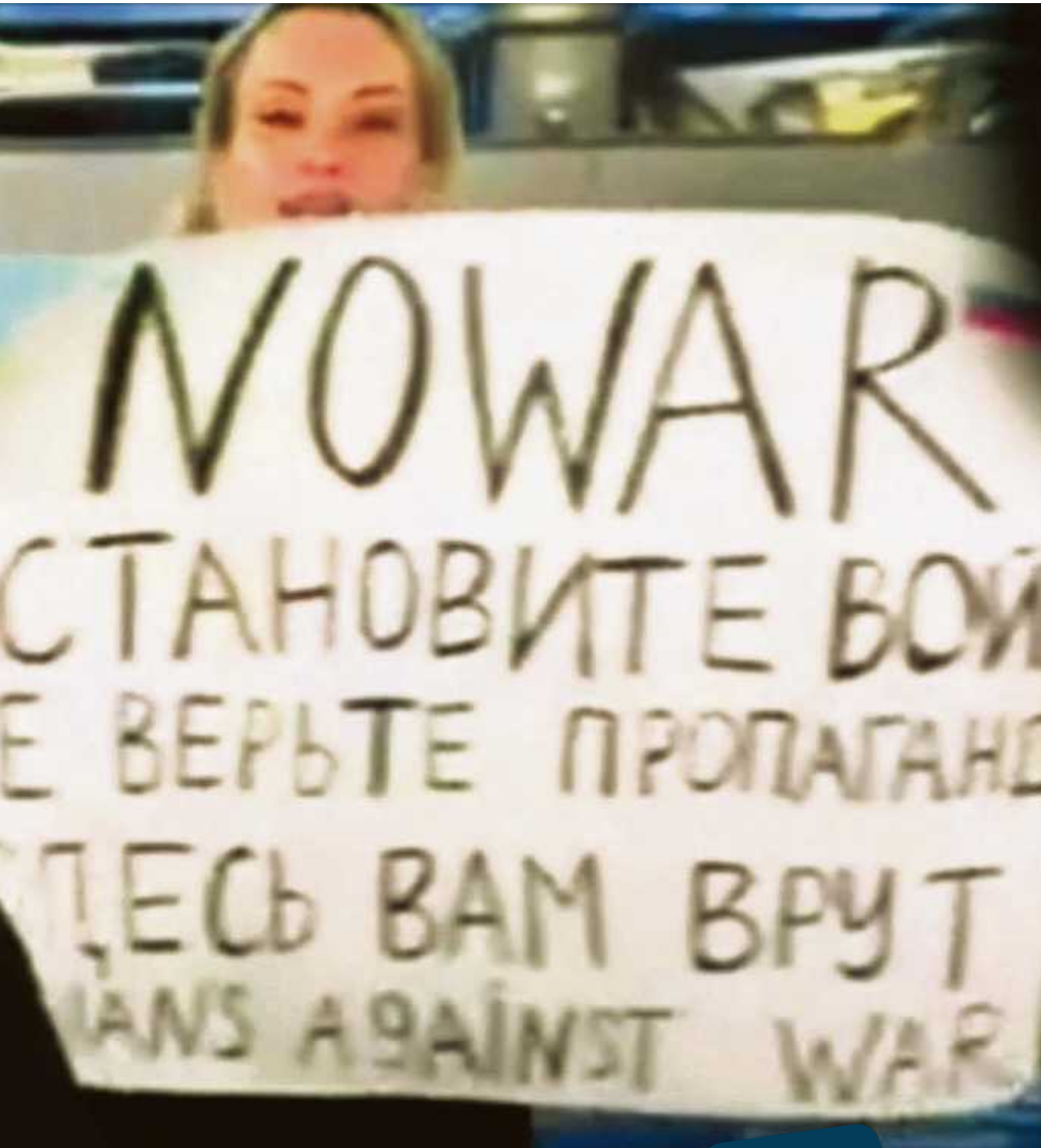

RELIEF Marina and her lawyer after court hearing yesterday

Telly protester's £215 fine after news demo

A RUSSIAN journalist who protested against the war in Ukraine on live TV news has been fined £215.

Marina Ovsyannikova appeared in a Moscow court yesterday and was ordered to pay 30,000 roubles.

The editor at state-controlled Channel 1 interrupted the bulletin with a sign saying "no war".

She also released a video calling the war in Ukraine a crime and urging Russians to protest against it.

The fine was imposed after she was found guilty of flouting protest laws with her video, the court said. It is not clear if she

will face separate charges relating to her TV protest under repressive new laws which carry a jail term of up to 15 years.

There were fears for her safety until a photo of her with her lawyer appeared online.



FEARS Protest journalist

After the hearing, she said she was quizzed for 14 hours with no legal help.

She said: "It was my anti-war decision. I don't like Russia starting this invasion. It was really terrible."

State TV insists the invasion is a "special military operation" to "de-Nazify" Ukraine.

A Kremlin spokesman denounced Marina's protest as "hooliganism".

said to have transferred shares to himself from an offshore company on February 16. But his £150million Kensington mansion in West London, a £22million penthouse, helicopters and supercars based in Britain cannot be sold.

It is understood he was not due to meet President Putin in Moscow.

But sources suggested he was keen to find a peaceful resolution to the conflict.

It was the second trip a jet linked to the oligarch has made between Istanbul and the Russian capital in a matter of days.

Data showed the jet in the Russian capital, with sources confirming he was on board on Thursday. Germany's Bild newspaper reported

he met with ex-chancellor Gerhard Schroeder in Moscow before Schroeder sat down with Putin.

A source told Reuters news agency that Abramovich "wanted to find a way to stop the war".

But Foreign Secretary Liz Truss pledged to hit hard those close to Putin for their "complicity in Russia's crimes in Ukraine".

The UK's sanctions regime is effectively now in line with the tougher one imposed by its European and other allies.

The EU launched a new barrage of sanctions yesterday including bans on Russian energy

370
Russian and Belarusian individuals and entities sanctioned yesterday

sector investments. And they also froze the assets of more Kremlin-linked individuals including Abramovich.

The UK slapped export bans on luxury goods such as sports cars and high-end fashion and hiked 35 per cent import tariffs on goods such as vodka.

The Foreign Office said the latest oligarchs sanctioned have a combined estimated worth of more than £100billion.

Ukrainian President Volodymyr Zelensky warned the sanctions, while welcome were "not enough", calling for a full trade embargo.

Prime Minister Boris Johnson, hosting a meeting of European leaders in London which Zelensky addressed via video-link, said he heard him "loud and clear".

Among hundreds of Russian and Belarusian individuals who have been hit with UK asset freezes and travel bans are former president Dmitry Medvedev, Russian Foreign Affairs spokeswoman Maria Zakharova and oligarch Mikhail Fridman.

But Lib Dems spokeswoman for foreign affairs Layla Moran said: "This is shutting the door after the private jet has bolted."



THE OLIGARCH

Mikhail Fridman

Ukrainian-born Fridman is founder of Alfa Bank, the largest private bank in Russia. Said to be worth £9.2billion. He moved to London in 2015, buying Athlone House in Highgate, and has business interests in the UK.

THE VOICE

Maria Zakharova

As foreign affairs spokeswoman, Zakharova is the international voice of the Putin regime. Claims videos of strikes against civilians are part of Ukrainian propaganda. The day before the war she was sanctioned by the EU as "a central figure of the government propaganda".

WAR IN UKRAINE:

Lesser

PM begs Saudis for oil... despite Yemen atrocities & 81 executions

BY RACHEL WEARMOUTH
reporters@dailyrecord.co.uk

AS Russia carries out new attacks against the people of Ukraine, Boris Johnson is heading to Saudi, where 81 people were executed this week for opposing its brutal regime.

The largest mass execution in its modern history was on the orders of Crown Prince Mohammed bin Salman, who is also guilty of the merciless bombing of civilians in Yemen and was implicated in the 2018 assassination of US-based journalist Jamal Khashoggi.

But the PM heads to Riyadh to beg Bin Salman to increase oil production to help the West wean itself off Russian energy.

He will make similar pleas to Crown Prince Sheikh Mohammed bin Zayed in the neighbouring UAE, also guilty of human rights abuses.

Johnson said: "The UK is building an international coalition to deal with the new reality we face."

"The world must wean itself off Russian hydrocarbons and starve Putin's addiction to oil and gas."

"Saudi Arabia and the United Arab Emirates are key international partners in that."

Pressed on whether the shift away from Russia meant dealing with other dangerous regimes, he said: "We want to build the widest possible coalition."

Ed Miliband, Shadow Secretary of State for Climate and Net Zero, said: "It

is a sign of our vulnerability and energy insecurity as a country that the Prime Minister is going to Saudi Arabia to seek an increase in oil production, despite the appalling human rights record."

Amnesty International UK's Polly Truscott said: "Saudi oil shouldn't be allowed to buy the world's silence over Saudi's terrible human rights record."

Mike Davis, of Global Witness, said: "Oil and gas drives conflict. Rather than run, cap in hand, to Riyadh, the PM should be focusing on how we can rapidly invest in renewable energy."



VICTIM Jamal

Conservative Julian Lewis, who chairs the Intelligence and Security Committee, called for assurances that the UK would not now become dependent on another "unreliable, sometimes hostile, regime".

Katie Fallon of the Campaign Against Arms Trade said Britain's weapons sales to Saudi had "emboldened" the kingdom to "commit violations" of humanitarian law in Yemen.

Johnson, who will travel overnight before starting in the UAE, wrote in the Telegraph yesterday: "As long as the West is economically dependent on Putin, he will do all he can to exploit that dependence... And that is why that dependence must - and will - now end."

Tory MPs yesterday urged Chancellor Rishi Sunak to combat "eye-watering" fuel costs by cutting duty.

BORIS Johnson is so desperate for oil he is willing to pretend this week's mass execution of 81 men never happened. The damage to Britain's moral standing globally is huge.

Mohammed bin Salman swore he is modernising the Saudi justice system but days later oversaw the country's largest mass execution.

He is betting countries like the UK will look away because they would rather fund his blood-soaked petro-state than Putin's war machine.

It is not an either/or. There are better and more sustainable ways to deal with the energy crisis than empowering these murderous regimes. Johnson's visit to Saudi will confirm it will face no meaningful consequences for these executions. It

They hope Britain will look away

COMMENT

BY MAYA FOA OF REPRIEVE



virtually guarantees more people, whose only crime was to protest against Bin Salman's rule, will be executed. People like Hasan al Maliki, an academic currently facing a death sentence for owning banned books.

The 81 executions at the weekend

were probably beheadings but Saudi "justice" is such a black box we can't be sure. The European Saudi Organisation for Human Rights, which tracks death sentences in Saudi, didn't even know about 69 of the cases. These men were tried, convicted, sentenced and executed in complete secrecy.

Of the 12 we know about, at least three were tortured into making false confessions to terrorism after taking part in pro-democracy protests.

Visiting Riyadh so soon after this mass execution shames the Prime Minister and shames Britain. We must not show our revulsion for Vladimir Putin's atrocities by rewarding those of Mohammed bin Salman.

Nisa

Making a Difference Locally

Make mine bangers 'n' mash!



Scan the code to find your nearest store

MID WEEK MEAL



RRP **£5.75**
667g

RRP **£1.65**
750g

RRP **95p**
170g

RRP **£1**
400g

*Deal includes: Co-op Irresistible Pork Sausages 667g, Co-op Mashed Potato 400g, Co-op Gravy Granules 170g, Co-op Garden Peas 750g.

£6*

For all this

SAVE £3.35

nisalocally.co.uk @nisalocally /nisalocally /nisalocally

Unless otherwise stated, all offers available from 9th March - 29th March 2022.

All offers subject to availability. Some variants may not be available in all stores and some offers may vary across stores. We reserve the right to limit purchases. All prices correct at the time of going to press. Price indications and savings relate to Nisa recommended retail prices and may differ in some stores.

RUSTLERS

SURPRISE YOURSELF IT'S BETTER THAN YOU THINK!

MADE WITH 100% BRITISH & IRISH BEEF



BUY NOW!

RRP **£2.10**

Cheap, ethical

BY JASON BEATTIE

THE war in Ukraine has exposed the fragility of the UK's energy supplies.

Embargoes on oil and gas from Russia have pushed up prices and sparked a scramble for supplies from elsewhere.

Ministers are trying to square the dash for new sources with net zero promises.

What can the UK do to bring down prices for consumers, secure its energy supplies and meet its green commitments?

OIL AND GAS

The Prime Minister will travel to Saudi Arabia and the United Arab Emirates to urge them to increase oil production. This would help bring down global wholesale prices.

Turning to Saudi Arabia is controversial



ALTERNATIVE Arab supplies are now vital

JOHNSON'S TAINTED MISSION

of two evils?



INNOCENT VICTIMS
Children at a refugee camp in Marib, Yemen



HELL Attack in Yemen's capital, Sanaa



TALKS Boris Johnson and Bin Salman in 2018



RT EARNINGS Salmond

Payback appeal to Salmond

BY PAUL HUTCHEON

ALEX SALMOND has been urged to give up money earned from the TV show he presented on a Russian state-backed broadcaster.

Scottish Lib Dem leader Alex Cole-Hamilton urged the former first minister to hand over fees to help the people of Ukraine.

Salmond fronted a current affairs programme on RT from 2017. In a statement last month, he said the show would be suspended "until peace is re-established".

The show was produced by Slainte Media. Salmond and co-host Tasmina Ahmed-Sheikh were co-owners between 2018 and 2020 and the latter is now the major shareholder.

Cole-Hamilton said: "The decent thing would be for him to surrender proceeds to charities helping Ukraine and its people in this their most desperate hour."

Salmond did not respond to an emailed request for comment.

£12k aid from Scots workers

BY ANDREA LAMBROU

A WORKPLACE whipround raised £12,000 to support the families of Ukrainian colleagues.

Staff at digital signage firm Merson Group rallied round to help 15 workers based in Wloclawek, Poland who have relatives in war-torn Ukraine.

Employees at the firm's East Kilbride office said they have been left "saddened" and "distressed" by the humanitarian situation.

With trucks bound for their Polish site each week, the Merson Group has already filled a lorry load of goods. CEO Roddy Angus said: "We have 15 Ukrainian colleagues in Poland who are in an unbelievably difficult situation."

"I'm amazed at the amount of money raised - it will make a big difference. We have vehicles driving to Poland every week so we plan to keep sending aid to different charities."

energy: The UK's alternatives

because of the country's human rights record but Whitehall sources have played down an immediate deal.

The UK is looking to issue new licences for North Sea oil and gas.

RENEWABLES

In 2020, Boris Johnson said he wanted 100 per cent of the UK's energy to come from renewables by 2035.

However MPs have warned recently that the target is unlikely to be met.

And any hopes of meeting it will be thrown into further doubt if the Government decides to turn to fossil fuels to plug the gap in energy

supplies. The Labour Party argues that the Government has been too slow to invest in solar, tidal and wind power.

It says there are 649 onshore wind farms and solar projects in the country which already have planning permission but have yet to be developed.

NUCLEAR

Britain gets just 16 per cent of its power from nuclear sources, compared with 71 per cent in France.

The Government's 2020 energy white paper identified nuclear as a way to cut emissions but just



one new nuclear power station, Hinkley Point, left, is being built. Ministers have named seven possible new sites but could also speed development of "mini" reactors - powerful enough to service a city.

FRACKING

Under pressure from the Tory right the Government has agreed to review its moratorium on fracking.

It was banned in the UK in 2019 amid concerns it was causing tremors but Boris Johnson has said it would not make sense to seal the country's shale gas wells.

Experts warned that it could take 10 years before the wells started to produce

gas commercially. Business Secretary Kwasi Kwarteng admitted that fracking would not change wholesale prices.

HOME INSULATION

One of the most effective ways to reduce heating bills is to insulate homes properly.

Labour's Ed Miliband says upgrading the 19 million homes without insulation would cut bills by an average of £400 a year and cut gas imports by 15 per cent.

But David Cameron cut subsidies for insulation and relaxed rules on new builds. Since 2016, more than a million homes have been built with poor energy ratings. Johnson's £1.5 billion green homes grants scheme was scrapped in 2021.

Workers hit by the worst pay squeeze for 8 years

WORKERS have suffered the biggest pay squeeze for more than eight years, according to figures.

The Office for National Statistics said that with rising prices taken into account, regular pay fell by 1.6 per cent year on year in the three months to January.

That's the steepest decline since 2013.

Average earnings, excluding bonuses, rose

BY HOLLY WILLIAMS

3.8 per cent in the latest quarter but failed to keep up with inflation of 5.5 per.

The Resolution Foundation has warned British households could be facing the sharpest decline in real incomes since the 70s.

Calls were growing for Chancellor Rishi Sunak to act in his spring statement.

TUC general secretary Frances O'Grady said: "We

need a plan to get wages rising in all jobs, a boost to Universal Credit and a windfall tax on oil and gas profits – with the money going to energy grants for hard-pressed families."

Sarah Coles, of Hargreaves Lansdown, said: "Unless you're one of the lucky few taking home a bumper bonus this winter, you're in for a horrible battle to make ends meet this spring."



UNDER PRESSURE Sunak

NetworkRail

Our stations are cleaned like clockwork.

We clean regularly touched surfaces and use antiviral spray around the clock at Edinburgh Waverley and Glasgow Central stations.



Travel with confidence at Edinburgh Waverley and Glasgow Central stations.

NICOLA Sturgeon has slammed the brakes on plans to axe face mask rules on Monday after a spike in Covid cases.

BY PAUL HUTCHEON
Political Editor

The First Minister said the delay will be reviewed in two weeks, with the "expectation" the legal requirement will become guidance in April.

Face coverings are currently required in shops and on public transport, as well when people are standing in pubs and restaurants.

Sturgeon previously signalled the curb would be scrapped on March 21 but rising Covid numbers have forced a rethink.

Addressing MSPs, she said the average number of cases is just over 12,000 a day – up from 6900 three weeks ago.

The number of people in hospital with Covid has also shot up to 1996 from 1060 over the same period.

Although the face mask rule has been axed in England, Sturgeon said: "Given the current spike in case numbers, we consider it prudent to retain this requirement in regulation for a further short period.

"I know this will be disappointing for businesses and service providers such as day care services.

"However, ensuring maximum widespread use of face coverings will provide some additional protection – particularly for the most vulnerable – at a time when the risk of infection is very high, and it may help us get over this spike more quickly.

"We will review it again in two weeks – before the Easter recess – and our expectation now is that this regulation will convert to guidance in early April."

A Government press release later stated that legal requirements on face coverings will continue until "at least early April".

Other legal measures, such as requiring businesses to retain customer contact details and firms having "regard" for Government guidance on Covid, will end on Monday.

Sturgeon said the rise in cases over the past three weeks has been driven by a "sub lineage" of Omicron.

She added: "I ask everyone to be patient for a little while longer on face coverings and to continue following all advice on hygiene, ventilation, testing and, of course, vaccination."

Meanwhile, she also announced free Covid testing for all in Scotland will be scrapped by the end of April.

Scots without symptoms will no longer be encouraged to take two lateral flow tests (LFTs) every week as of April 18, while those who do have symptoms will be expected to take a PCR test until the end of next month.

Free access to LFTs will end on April 18, except for those working in health and social care and for people visiting vulnerable individuals in care homes or hospitals.

Those living in close contact with people who test positive will also be asked to continue taking daily LFTs

for one week. Sturgeon said her Government's "freedom of manoeuvre" is "severely limited by the fact that our funding is determined by UK Government decisions taken for England".

Dr Liz Cameron, Chief Executive of the Scottish Chambers of Commerce, said: "The decision to delay the removal of all remaining Covid-19 restrictions will come as a bitter disappointment.

"Further delay will put Scotland's recovery into reverse gear again, create confusion, dent business confidence, putting the buffers on economic growth.

"The Scottish Government must commit to the removal of all remaining restrictions as soon as possible whilst providing greater detail on what triggers sit behind the decision-making process to protect consumer and business confidence."

Andrew McRae, of the Federation of Small Businesses (FSB) in Scotland, said: "Businesses in Scotland face far fewer restrictions now than they did earlier in the pandemic. And today the First Minister outlined a timeline to lift many of the remaining rules, albeit slower than many would like.

"However, the impression that Scotland has a 'first in, last out' approach to Covid restrictions

Free access to LFTs ends on April 18

...except for those working in health and social care and for people visiting vulnerable individuals in care homes or hospitals.



frustrates many in business. At a time when debt-laden firms are facing dramatic fuel and utility hikes, operators are looking for Ministers to inject confidence, not seed doubt."

Professor Andrew Elder, president of the Royal College of Physicians of Edinburgh, said: "Given the high and increasing number of Covid-19 cases, it is sensible for face coverings to remain mandatory for now.

"The College notes face coverings, alongside good hand and respiratory hygiene and simple social distancing can all help to reduce the spread of Covid-19. That is why we support the Scottish Government's decision.

"Older people and those of all ages made vulnerable to infection because of pre-existing conditions remain particularly at risk – we should remember that this remains the case. This virus has not left us."

Scottish Tory leader Douglas Ross said: "It's bad enough the First Minister has gone back on her word to businesses and the public by extending the face mask requirement.

"But, worse still, she could not even guarantee that this would only be for a further two weeks. We can't stay stuck with Covid rules forever."

CRISIS

RULE STAYS FOR AT LEAST TWO WEEKS



UNDER COVER Masks are staying for now

Sturgeon halts plan to axe masks on Monday after cases spike again



Q&A

Q: Do I still have to wear a face mask?

A: Yes, when visiting shops, using public transport or when moving around a venue like a pub or restaurant.

Q: When will the face mask rule end?

A: The legal requirement will be reviewed in two weeks and the First Minister has suggested it could be scrapped before the Easter weekend.

Q: So what rules have actually changed?

A: Venues like pubs and restaurants will no longer be required to take customers' details as of Monday

Q: Is Covid testing ending?

A: Not completely but it will be massively wound down between now and May. Tests will become targeted and won't be offered to everyone as a matter of routine.

Q: Will I still be able to claim free LFT tests?

A: The general public are being encouraged to test themselves twice a week - even if they don't have symptoms - with a lateral flow test until April 18, when the free supply will end.

Q: Will remote testing sites remain open?

A: Testing sites offering PCR tests are scheduled to close by the end of April. If you display Covid symptoms before then, you are still encouraged to book one.

Q: What should I do if I live with someone who tests positive?

A: You should continue to follow existing guidance and take an LFT each day

Q: What should I do if I display Covid symptoms from May onwards?

A: There will be no legal requirement to get tested but the public will be encouraged to remain at home until they are well.

Q: What about people who work in health or social care?

A: Medical or care staff will still be able to obtain free LFTs beyond April.



ABOUT FACE!

Wilko in U-turn on Covid policy

RETAILER Wilko has apologised and made a swift U-turn after it told staff they could attend work even if they test positive for Covid-19.

The discount chain said in a new policy document to workers: "If you test positive for Covid-19 and feel well you can continue to come to work, if you feel too unwell you can follow the absence policy."

However, Jerome Saint-Marc - chief executive of the firm, which employs about 16,000 staff at more than 400 UK stores - has apologised and blamed "miscommunication".

He said: "When we get something wrong, we hold our hands up, admit it and work to correct the situation. Today's news has highlighted some miscommunication within our Covid-19 policies and I wanted to reassure all our customers and team members.

"Our advice to team members that have Covid symptoms or test positive is that while they're no longer required by law to self-isolate, they should still stay at home and avoid contact with others. This will help reduce the chance of spreading Covid-19."



NOTORIOUS Michael Carroll blew his cash

Lotto draw since 1994

- National Lottery set up in 1994 by prime minister John Major's government.
- He bought a ticket and aides worried he would win the first draw, papers released in 2019 showed.
- Camelot wins first licence, and contracts in 2001 and 2007 for second and third.
- The award of the second only came after a High Court battle, when Virgin tycoon Sir Richard Branson had initially been picked.
- Noel Edmonds and Anthea Turner, watched by 22million, hosted the first draw, on Saturday November 19, 1994.
- Deborah Walsh, 18, won a contest to press the button to start the draw machine.
- The first winning numbers were 3, 5, 14, 22, 30, 44 and the bonus ball was 10.
- Scratchcards were launched in March 1995.
- EuroMillions draw launched in February 2004.
- Main draw ticket doubled to £2 in October 2013.
- Lottery has created more than 6300 millionaires.
- More than £45billion raised for 660,000 good causes.
- Anonymous UK ticket holder wins £170million EuroMillions jackpot in 2019, beating £161million won by Scottish couple Colin and Chris Weir in 2011.
- Lotto rapist Iorworth Hoare won £7.2million in 2004 on weekend leave from jail.
- Builder Edward Putman was jailed for nine years in 2019 for claiming £2.5million with fake Lottery ticket.
- "Lotto lout" Michael Carroll blew 2002 £9.7million win.
- Camelot warned of a "low level" cyber attack in 2018 affecting 150million online customer accounts.



UNLUCKY Mr Major



TWO DRAWS ON ONE NIGHT

LUCKY BIDDER
Komarek and his wife Stepanka

TICKET PRICES BACK TO £1

DEATH OF THE SCRATCH CARD?

£38bn FOR GOOD CAUSES

THE LOTTERY REVOLUTION

BY **GRAHAM HISCOTT**

A BILLIONAIRE with business links to Russian energy giant Gazprom is set to be handed control of Britain's National Lottery.

The Gambling Commission has chosen Allwyn, owned by Czech tycoon Karel Komarek, as its "preferred bidder" to operate the lottery licence from 2024.

Komarek made much of his fortune in oil and gas but has been keen to distance himself from Russia amid the war in Ukraine.

The decision is a blow to Camelot, which has run the National Lottery since its launch in 1994, and chief executive Nigel Railton said it was

Russian-linked firm wins deal

considering its "next steps". Because of the secretive nature of the bidding process, Allwyn has yet to reveal much about changes players and sellers can expect.

But reports say it pledged £38billion to good causes over 10 years, plans to halve ticket prices to £1 and have two draws per night.

Elsewhere in Europe, Allwyn focuses on online sales. It promotes "giftcards" instead of scratchcards.

It is also known to use algorithms to predict and prevent problem gambling, which may have impressed

the Gambling Commission. Komarek wrote an open letter in early March condemning Russia's "brutal" invasion.

He said he decided "many years ago" to sell his assets in Russia.

However, his company still shares ownership with Gazprom of a gas storage facility in the Czech Republic.

Komarek explained: "This joint venture has been maintained, at the request of the Czech government, to ensure an important Czech energy asset was not subject to full Russian control. There are very few options to

fully divest from Russian gas in Eastern Europe."

Gazprom, which is majority owned by the Russian state, has been sanctioned due to the invasion of Ukraine. The Gambling Commission insisted it was "satisfied no application is impacted by sanctions related to the conflict". Entrepreneur Komarek, 52, started out selling pipes and valves, then moved into oil and gas.

The dad of four is worth an estimated £5.9billion, is married to Stepanka and lives in Switzerland.

5.9
Wealth in billions of pounds estimated for Allwyn boss Komarek



HOSTS Noel and Anthea



POP-UP Richard Ashcroft

Ashcroft to star at June Big Top gig

BY RICK FULTON

FORMER Verve frontman Richard Ashcroft will headline Edinburgh's latest pop-up venue – The Big Top at Royal Highland Centre Showground on June 17.

The man behind 90s anthems such as Bittersweet Symphony and The Drugs Don't Work has carved out a successful solo career since the band split.

Organisers said: "Best known as the lead vocalist and frontman of The Verve, Ashcroft proved himself the spiritual descendant of rock and roll icons like Mick Jagger and Jim Morrison."

The singer joins Madness, Fatboy Slim, Biffy Clyro, 50 Cent and Snow Patrol who all have their own headline shows this June. Tickets for Ashcroft go on sale from 10am this Friday via gigsinscotland.com.



STORY Sharon Osbourne

Sharon's set to throw the book at Ozzy

BY DAVID O'DORNAN

SHARON Osbourne is bringing out a fourth instalment of her memoirs later this year – and this time hubby Ozzy is in the line of fire.

The former X Factor judge's tell-all autobiography will expose the Black Sabbath hellraiser's affairs and drug benders.

The couple have been married for 40 years and Sharon, 69, has stood by Ozzy, 73, despite blasting him in the past for his bed-hopping.

She is expected to dish the dirt on Ozzy's cheating, having already mentioned some of the affairs in an interview three years ago.

Sharon said at the time: "There were six of them – some Russian teenager, then a masseuse in England, our masseuse out here, and then our cook."

Look up... JLo's selling eyewear

YOU'D be forgiven for thinking Jennifer Lopez was plugging a new range of lingerie but the pop superstar is pictured in the latest campaign for Dolce & Gabbana's new eyewear range, where she was joined by British male model David Gandy.



EYE CATCHING Jennifer Lopez and David Gandy in D&G glasses



ROBBIE LIFE ON SCREEN

Film could deliver US fame at last

BY TOM BRYANT

SINGER Robbie Williams could be set to conquer America for the first time, with his life story.

Despite huge success in Europe and Asia, Williams has found the US market difficult to crack.

But Hollywood bosses have high hopes a big-budget film about him will prove a hit like Bohemian Rhapsody and Rocketman – the stories of Queen and Elton John.

A source said: "Movie chiefs think the script – essentially a stirring story about an underdog catapulted to fame – will really resonate with people, even those in America who may not know much about Robbie."

The film is being directed by Michael Gracey, who made The Greatest Showman.

Robbie, 47, whose hits include Angels and Let Me Entertain You,



'WARTS AND ALL' Robbie biopic

is expected to appear as himself in the biopic, which will tell of his rise to fame with Take That and a successful solo career.

He says the movie, called Better Man after one of his songs, will be "warts and all" and not be afraid to address issues such as addiction.

He told this week how he poured his heart out to Gracey then "ran away and hid behind a sofa".

help

We know everyone wants to help those affected by the crisis in Ukraine. You can now donate to the British Red Cross' Ukraine Appeal by rounding up your shop in-store to the nearest £1 at the self-service tills or by donating your Clubcard vouchers online. We'll match your donations in the UK up to £700k, with a further £300k donated across ROI and Central Europe, totalling £1m. Let's help, together.

Visit tes.co/everylittlehelps for details.

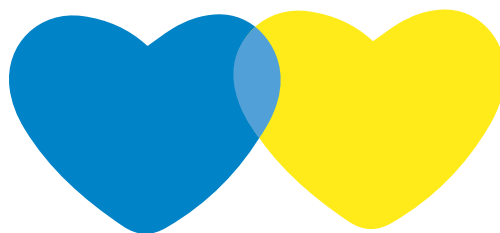

TESCO

Supporting



GOVERNMENT TARGETS FURTHER DROP

CAUTIOUS HOPE AS DRUG DEATHS FALL



CRISIS Rachel Statham
30,000 kids to miss out in poverty plan

BY KATHARINE HAY
 THE Scottish Government is set to miss its child poverty targets, a report shows. Its aim is to have less than 10 per cent of children in households living in relative poverty by 2030.

But a report written by think tank the Institute of Public Policy Research said the doubling of the Scottish Child Payment (SCP) – from £10 to £20 a week – next month would result in the scheme falling 30,000 children (three per cent) short of the target.

It said the value of the payment would have to double again from £20 to £40 by the end of this Parliament for the target to be met.

Rachel Statham, of IPPR Scotland, said the SCP must go “further and faster” and added that “an urgent review” of crisis support offered through the Scottish Welfare Fund was needed.



TALENTED Paul Hampshire
Ex-football star killed in car tragedy

BY SARAH VESTY
 A FORMER footballer has died after being hit by a car. Ex-Raith Rovers midfielder Paul Hampshire was pronounced dead at the scene of the incident on the A1 near Dunbar in East Lothian on Sunday.

Emergency services were called at about 1am after a black Ford Fiesta collided with the 40-year-old.

A probe is ongoing as tributes were paid to Paul, who also played for Berwick Rangers and East Fife.

The dad was hailed a “class act” and a footballer with a “wonderful left foot”.

A statement from Raith Rovers said: “The club were saddened to learn of the passing of former player Paul Hampshire.

“Paul is remembered as being blessed with a wonderful left foot.

“Our thoughts are with the Hampshire family.”



BY MARK MCGIVERN
 Chief Reporter

THE drug deaths crisis shows signs it might be improving as new figures reveal an eight per cent reduction last year.

The significant downturn has sparked cautious optimism that the nation might be turning a corner after years of campaigning by the Record for action to tackle the problem.

Fewer young people are believed to have died than in previous years but more women were lost to overdoses in the stats, which has sparked concern.

The Police Scotland figures estimated a total of 1295 drug deaths in 2021 – down from 1411 for 2020.

Scotland’s drugs policy minister Angela Constance reaffirmed her determination to turn the crisis around.

She said more people will be able to get treatment and that targets for rehab will soon be published as part of plans to cut deaths further.

Constance added: “I know that despite this decline in the number of suspected drug deaths, the figure is still far too high and, as I have said before, there is much hard work to be done to turn this public health emergency around.

“Getting people into the treatment which works for them is key and we continue to embed the new Medication-Assisted Treatment (MAT) standards – which reinforce a rights-based approach for people who use drugs and the



“There is much hard work to be done to turn this situation around”

ANGELA CONSTANCE



“Scotland is the most dangerous country in Europe for a drug user”

PETER KRYKANT

more than 12,000 people to overdoses. Our death rate remains more than three times that of the UK as a whole.

Scots from poor communities continue to be grossly over-represented in the drug death figures – being more than 15 times more vulnerable to overdose.

And there remains a chilling reality that many of those who fall into reckless polydrug use – almost always fuelled by cheap street Valium – are doing so in full



But activist insists ‘heartbreaking’ number should be viewed as another year of failure

treatment they should expect, regardless of their circumstances.

“There has been a slight increase in the number of deaths among females and we are committed to tackling the barriers which prevent women from accessing treatment, support and recovery.

“One of our priorities is to develop and increase women-specific services, and services to keep children and families together.” The

annual figures were released after police provided their latest quarterly report on the deaths.

The police stats are put together after toxicology tests are analysed.

The report said there were 1295 deaths between January and December 2021, while National Records of Scotland figures showed 1339 deaths.

Among those, there were 356 suspected deaths of females, an

increase of three per cent compared with 2020. Deaths in the under 25 age group was 68 – 20 fewer than 2020.

Activist Peter Krykant said the figures should not be seen as progress and showed a “natural plateau”.

He added: “This utterly heartbreaking number shows another year of failure and incompetence.

“Scotland is the worst and most dangerous country in Europe to be a person who uses drugs.”

ANALYSIS TURNING POINT OR A FALSE DAWN?

SCOTLAND still has Europe’s worst drug death rate – which is hardly an occasion to celebrate.

But the latest stats suggest a sizeable reduction of eight per cent in overdose deaths.

We must retain a sense of perspective when looking at these figures, however.

The downturn in deaths take us to the levels of 2019 – which were regarded as a national disgrace. Since 2007, we’ve lost

more than 12,000 people to overdoses. Our death rate remains more than three times that of the UK as a whole.

Scots from poor communities continue to be grossly over-represented in the drug death figures – being more than 15 times more vulnerable to overdose.

And there remains a chilling reality that many of those who fall into reckless polydrug use – almost always fuelled by cheap street Valium – are doing so in full

knowledge that they put their lives on the line.

The drivers of this include childhood trauma, poverty, bereavement, homelessness and, very often, hopelessness.

Yet there are clear signs of improvement – and an obvious desire from drug minister Angela Constance to make a difference.

More money for drugs programmes

and new guidance for the prosecution of drug offences signal a softening in the harsh and sneering attitudes long held by many against those suffering from addiction.

We will only know if real change is coming when we see consecutive years of meaningful improvement.

But hopefully this reduction will be a turning point in our battle against drug deaths – not another false dawn.

Everton ace fined for 8mph over limit in a Lamborghini

EVERTON star Dominic Calvert-Lewin will have to stump up more than £1500 after being caught driving 8mph over the speed limit in a Lamborghini.

The 24-year-old striker admitted driving at 58mph in a 50mph zone on the A533 in Runcorn, Cheshire, last August.

At Chester Magistrates' Court yesterday, he was issued with three penalty

BY ELEANOR BARLOW

points and ordered to pay a £900 fine, £620 costs and a £90 surcharge.

The footballer, who did not attend court, had been due to stand trial after initially pleading not guilty to speeding and failing to give information about the driver of the car.

But his solicitor, Barry Warburton, said he would be changing his plea to

exceeding the speed limit to guilty. Mr Warburton told magistrates: "I think you are probably aware he is a professional footballer. He has a disposable income in excess of £450 a week."

Chair of the bench Roy Baron ordered Calvert-Lewin to pay £1610 within 28 days. The court was told he already had three points on his licence from a speeding offence in 2020.



3 POINTS Calvert-Lewin

EXCLUSIVE BY EMILY RETTER

WHISPERING Bob Harris is issuing the warmest greeting, those familiar white teeth gleaming, that unmistakable melodious voice coating our conversation like honey.

It has purred from radio and TV for five decades, from 1971 holding court on cult music show *The Old Grey Whistle Test*, introducing generations to new stars including Elton John, David Bowie, Bob Marley and the Wailers and Blondie.

Fans may have heard him more recently on his Radio 2 show, *Bob Harris Country*.

Today, the DJ who toured with Queen, sang with Bowie, "hit it off" with John Lennon and counts Led Zeppelin's Robert Plant as a close pal, is silhouetted against shelves of "around 18,000" CDs in the sunlight of his *Under The Apple Tree* studio.

Aged 75, Bob is still passionate about music, still working hard.

The dad of eight and grandad of six has just been part of C2C: Country to Country. The festival has been a regular at London's O2 arena since 2013.

But beneath the soundtrack of perfect contentment, Bob is touchingly open about his ongoing health issues. He's also candid about his fears.

In 2007, he was diagnosed with prostate cancer, and today admits that although it is "under control", it has spread, including a little to his bones.

In 2019, he suffered a terrifying aortic dissection – a sudden tear along his aorta, the main artery that carries blood from the heart.

He was rushed to hospital, where scans picked up signs of spreading cancer.

Bob said: "I wouldn't like to alarm anyone or over-dramatise it, because I'm OK, we have everything under control, I don't feel ill. I go into hospital once every two months for a two-day stay, intravenous radiotherapy that keeps my cancer under control. Every morning I take an absolute fistful of tablets."

Yet, he revealed, he has moments of panic, and believes he is dealing with PTSD, like so many who experience aortic dissection.

"Sometimes I wake up in the morning really struggling to contain a massive panic attack," he admitted.

"After the dissection I started to cry, and once I started I couldn't stop. I cried solidly for about two weeks. It sounds unbelievable. I tried to compose myself and didn't find it possible."

He eventually rang close friend and fellow DJ Johnnie Walker for comfort. He also got in touch with Plant, who had counselled him after his diagnosis.

Bob said: "I get very frightened, you worry there will be some recurrence. I try and say, 'Look, you can overcome these worries and just live your life.'"

"The thing you'll always regret if you don't is huddling somewhere feeling frightened by life."

"I try and get on and live life as best I can, I bless the days I have now. This is pure Bob."

The lad from Northampton, who became a police cadet to please his Welsh policeman dad, has never huddled away from life.

After trying his best at law enforcement, he had the courage to quit and follow his dreams to *Swinging*



INTERVIEW Singer set up Lennon chat

ELTON JOHN



PALS Bob with the Led Zeppelin frontman

ROBERT PLANT

His cult TV show *The Old Grey Whistle Test* brought Elton, Bowie and Marley into our lives and at 75 Bob Harris is still championing music

The

London, where he tried his hand at music journalism.

It was 1967 and he was 19.

In 1968, he set up *Time Out Magazine*, and after befriending DJ John Peel he got a lucky break standing in for him on Radio 1. By 1970, he was presenting *Sounds of the Seventies*. His TV break followed on *Whistle Test*. The anecdotes Bob tells purr on and on. He became close pals with a pre-fame Bowie, even introducing him to

a crowd at a mobile disco he was running,

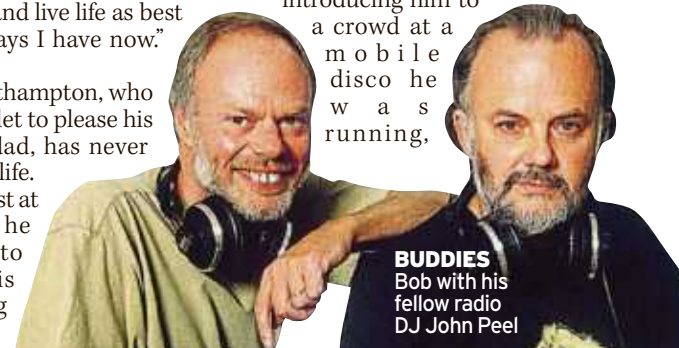

BUDDIES Bob with his fellow radio DJ John Peel

OK!
Beauty
BOX

DISCOVER NEW BEAUTY PRODUCTS AND ENJOY A MONTHLY ME-TIME TREAT DELIVERED STRAIGHT TO YOUR DOOR

GET YOUR FIRST BOX FOR **JUST £4.95*** WORTH MORE THAN **£95!** FREE P&P**

94% OF SUBSCRIBERS SAID THE BOX ALWAYS CONTAINS HIGH-QUALITY PRODUCTS

88% TRUST OUR BEAUTY RECOMMENDATIONS

81% OF THEM WOULD RECOMMEND TO A FRIEND

SCAN ME

SUBSCRIBE & SAVE AT **OKBEAUTYBOX.CO.UK**

Terms and conditions apply. *£4.95 is only available to new customers. OK! Beauty Box is £15 per month thereafter. **Surcharge delivery costs apply to Northern Ireland and Channel Islands. Figures are derived from a survey conducted across 500 OK! Beauty Box subscribers, 2022

MARC BOLAN



JOHN LENNON



BILL HALEY



Rockstar Whisperer

where the soon-to-be legend was booed off stage.

Bob said: "I strode out to the mic, incensed, red in the face, and said, 'What do you think you're doing? You'll remember this night!'"

"This guy is going to be a star!"

They used to visit each other's homes for dinner and Bob even ended up singing the chorus on Bowie's track Memory of a Free Festival.

He witnessed the breakthrough on Top of the Pops when Bowie sang Starman in 1972. And then, sadly, the singer cut ties with his old gang.

Bob said: "I wasn't hurt to start with but gradually I was. It was clear I wasn't going to be able to get through to him again."

"He and Marc Bolan were so important in my life in the late 60s, and John Peel, they were three of my closest friends. I always hoped there would be some bridge back towards

David, that would have been nice." Bob has interviewed music luminaries including Bill Haley but Lennon is his all-time favourite interviewee.

In the chat, facilitated by friend Elton John in 1975, Bob and John hit it off. Lennon was in a good place, back in New York and had just found out Yoko was pregnant.

"He asked us to take him chocolate Oliver biscuits, which he couldn't get out there," Bob chuckled.

He had declined a fee but the BBC insisted on paying its usual rate - £15.

"John said 'Could you bring me out £15 worth of chocolate Olivers then?'"

"It was just one of those things, we just got on." Bob got on less well with the Sex Pistols. In 1976, they started on him in a bar because he hadn't invited them on Whistle Test.

It was only because it was an album show - and they hadn't produced one. Things became very rock'n'roll for

Bob for a while, taking numerous trips to LA each year. Eventually his first marriage broke down.

His wife now, Trudie, is his third.

He partied with all the stars of the day, saying: "The only people I haven't met are Bob Dylan, Joni Mitchell, Neil Young."

But he insisted he was always aware of his BBC credentials, no matter how swinging situations became. So didn't fully partake in the partying.

He described being in the Rainbow Bar and Grill on Sunset Strip when he was invited to a Deep Purple party at a mansion, saying: "There was a party like you've never seen a party."

"All sorts of stuff was going on, I realised what an extraordinary rock 'n' roll moment this was -

then I saw blue lights at the bottom of the drive, five or six police cars.

"The place was being raided - the first thing I thought was 'BBC'." He and his group left sharpish. Today he still adores the social side of his job.

Shielding in lockdown, he said Zoom calls with the other Radio 2 DJs kept him going. "On a Tuesday we'd all get together, I'd

see Michael Ball in his kitchen, Ken Bruce did a couple in bed! Elaine Page in her conservatory, Jeremy [Vine] on his bike somewhere..."

The backstage atmosphere of Country to Country is what he loves best. Despite his nickname, Bob doesn't whisper his way through life.

He never has done and is certainly not about to start now.

"I feel I have got so much from life - but also there's so much of life still to live," he said.

Bob's four-part series, 21st Century Country, and highlights of shows from C2C Country to Country are all on BBC Sounds. The Country Show with Bob Harris is on Thursdays at 9pm on BBC Radio 2.

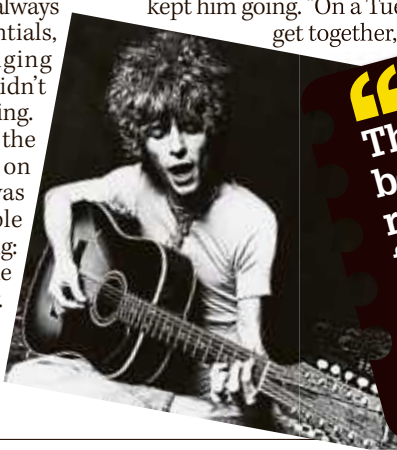

"The crowd booed Bowie.. red-faced with fury, I said 'This guy will be a star!'"

BOB HARRIS ON DAVID BOWIE APPEARANCE AT DISCO HE RAN

New safety rules 3 years too late for our Amanda

Grieving family lash out at health board



DEARLY MISSED
Amanda Cox with husband Michael

BY SARAH VESTY

THE family of a mum who collapsed and died just hours after giving birth have blasted a health board for a "catalogue of errors in her care".

Amanda Cox, 34, went missing inside Edinburgh Royal Infirmary in December 2018, sparking a seven-hour police search.

She was eventually discovered within a rarely used hospital stairwell and pronounced dead a short time later.

Amanda, from Peebles in the Borders, had just given birth to premature son Murray and is believed to have become disoriented after leaving the neonatal unit. Her cause of death was confirmed as an intracranial haemorrhage – bleeding in the brain.

NHS Lothian launched an investigation and apologised to her family. But the Crown Office said a fatal accident inquiry into the death



SEARCH ALERT Edinburgh Royal Infirmary will not be held as safety measures have been brought in by the health board.

In a statement, the family said: "The new safety measures come three years too late for Amanda. She did not deserve such a catalogue of errors in her care."

NHS Lothian medical director Dr Tracey Gillies said: "We are so sorry she died in our care. Following a review, a robust action plan was put in place to improve maternity patient pathways, upgrade signage and extend CCTV surveillance throughout the hospital."

Car blazes in 'war zone'

A STREET has been dubbed a "war zone" by residents after three vehicles were petrol bombed.

They were set alight in Newbattle Avenue, Airdrie on Monday night.

A Range Rover Evoque is understood to have had a petrol bomb thrown through a window. A van parked behind it caught fire and a third car in a driveway further down the street was also set alight.

Detectives were yesterday collecting CCTV footage of the incident.

Man dies at industry unit

A MAN who was killed following an incident at a factory was last night named locally as Liam Gallon.

The 32-year-old, from Montrose, died on Monday after sustaining fatal injuries in a building in Brechin owned by RyBay Corrosion Services.

Health and safety officials have begun a probe into circumstances surrounding the incident.

RyBay Corrosion Services has made no comment and deleted its Facebook page several hours after the incident.

Hannah. PensionBee customer since 2020

"Combining my five old workplace pensions was easy. I now feel happy about the future."

Combine, contribute and withdraw online



It's a fact that people change jobs more regularly nowadays. And that can often create multiple pension pots that are difficult to keep track of. PensionBee can bring your old pensions together into one new online plan. You can track your savings progress and easily adjust your contributions in a few taps via the app, and you can even opt for a socially responsible plan. This is what control feels like - and it feels good.

PensionBee
BE PENSION CONFIDENT

Alton Towers couple's wedding joy

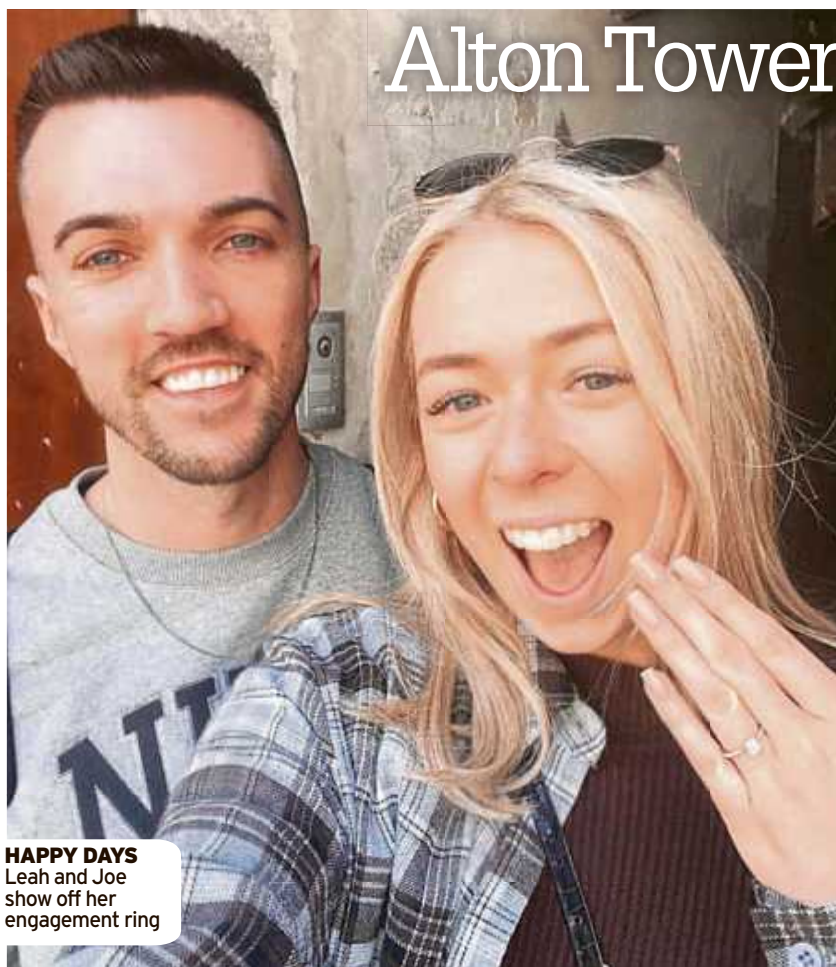

HAPPY DAYS
Leah and Joe show off her engagement ring

A COUPLE who were seriously injured in a rollercoaster crash at Alton Towers on their first date have announced their engagement.

Leah Washington, 24, and Joe Pugh, 25, were teenagers when the Smiler ride crashed in 2015 leaving them with devastating injuries.

Leah's leg had to be amputated and Joe had shattered knees but their romance carried on and earlier this week he proposed on a break in Venice.

Showing off her diamond solitaire ring in a photo with Joe, Leah told her 25,000 Instagram followers: "So this happened yesterday ... I SAID YES."

Joe posted: "What a great end to a long weekend in Venice... SHE SAID YES".

His mum gave her blessing to the engagement, commenting: "Fabulous news. Lots of love to you both."

Leah and Joe recently bought their first home together, a bungalow in Yorkshire, and started their own printing business together. The couple, from Barnsley, were among 16 people hurt when two carriages on the ride collided.

Theme park owner Merlin admitted breaching the Health and Safety Act and was fined £5million in September 2016.

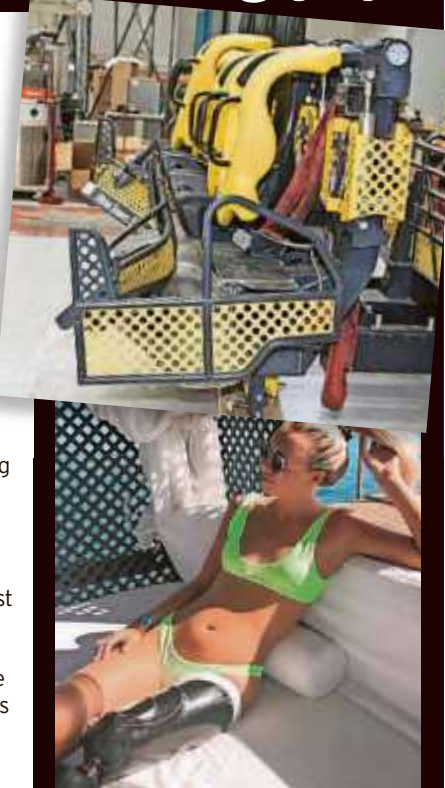

ORDEAL Leah, above, lost a leg in crash. Top, the carriage involved in the smash

Perv priest put on sex offender list

A CATHOLIC priest who sexually assaulted a parishioner as she delivered a meal to him on Christmas Day has been placed on the sex offenders register for five years.

Father Martins Enegbuma was also ordered to wear an electronic tag and stay at home between 7pm and 7am for four months.

Enegbuma, 44, ran his hands over the woman's body, rubbed her foot and kissed her at his home next to Our Lady Mother of the Church in Edinburgh's Lanark Road West.

The disgraced priest, originally from Nigeria, denied the attack on the woman, who is in her 20s, but was found guilty after a trial at Edinburgh Sheriff Court last month.

He was back in the dock for sentencing yesterday when a sheriff called the offence in 2020 "a serious breach of trust".

DRINK-DRIVER'S CRAZY EXCUSE

I've only had prosecco and spirits

Teacher caught after argument with her boyfriend

A SECONDARY school teacher who was caught drink-driving told police she had only had "prosecco and spirits".

Rosin Miller had been drinking with her boyfriend when a row broke out which resulted in Miller – who was three times the legal limit – getting behind the wheel of her car to "calm down."

Miller, 28, who works for Glasgow City Council, was arrested after her boyfriend called the police to report she was drink-driving.

Prosecutor Carly McLeod told Paisley Sheriff Court that police had been called to the town's Friarshall Gate on February 13 after a report of a driver under the influence.

She added: "Officers observed the accused in the driver's seat and no one else in the car. Police activated

TIPPLE Prosecco



BY **EMYLIE HOWIE**
emylie.howie@reachplc.com

their blue lights and Miller stopped her vehicle and immediately opened the door and said, 'I am sorry, I have only had a couple of drinks.'

"Police removed the keys from the ignition and the accused said, 'Aye, I've been drinking but I've only had prosecco and spirits.'

"A roadside breath test was carried out which Miller failed.

"She was arrested and taken to Govan police station where she provided a further two samples with the lowest being 70mg of alcohol in 100ml of breath.

"She was cautioned and charged and made no reply."

Miller, of Paisley, admitted she drove her Citroen C4 Cactus with 70mg of alcohol in 100ml of breath. The legal limit is 22mg.

Kris Buchanan, defending, told the court the teacher was

"extremely upset", adding: "Ms Miller accepted responsibility straight away.

"She and her partner had taken drink and an argument between them began.

"She left to calm down and in the heat of the moment made a foolish error of judgment and got in the car to drive to a car park. It was a short distance and she returned home.

"Her boyfriend was concerned for her welfare and contacted the police.

"She has intimated this to her employers who are supportive and have referred her to a support scheme, and she imagines she will be referred to the General Teaching Council.

"She has realised the foolishness of her actions."

Sheriff Tom McCartney fined Miller £640, reduced from £900 for her early plea.

She was also banned from driving for 14 months but if she completes a rehabilitation programme, that will be cut by three months.

Daily Record
Bingo!

SPIN TO WIN UP TO £6,000 WELCOME BONUS

JOIN NOW AT DAILYRECORDBINGO.CO.UK

WHEN THE FUN STOPS STOP BeGambleAware

Deposits required, wagering requirements apply. 18+. UK only. Full T&Cs apply.

Daily Record | OFFERS



FOR ALL LOVING CAT OWNERS

FREE SNUG CAT BED
(normally £17) on orders £25+

Do you know what's in your cat's food?

Many cat foods contain a lot of junk. They have a low percentage of meat or fish and contain cheap fillers that leave your cat feeling unhealthy and hungry.

At Nokular, we believe in feeding your cats the very best.

The Applaws food we offer is 100% natural and vet-recommended. It includes prime cuts of meat, with no hidden ingredients.

We know cats are really fussy. Their diet needs to be right. Give us a try - we hope they'll love it!



FREE
delivery to
your door



At Nokular, we believe cats deserve the very best. That's why we work hard to source the best food for your fussy cats!

We know that every cat has different needs and appetites. We offer our wet food in a variety of pack sizes so you can choose what is right for you and your cat.

Thank you for giving us a try.
Riana and Matt

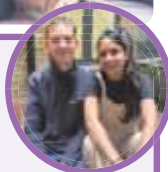

Products and Prices

Applaws Dry Food
2kg Bag
Chicken Flavour - £21



Applaws Wet Food Tins
Fish & Chicken
Flavours in Broth

12x 70g servings - £19
24x 70g servings - £30
48x 70g servings - £48



Flavours: Tuna, Ocean Fish, Chicken, Chicken & Cheese

This wet food is complementary - please feed with any dry food for a complete and balanced diet.

Whiskas Dentabites
Adult Chicken Treats
4x 50g packs - £6
8x 50g packs - £11



We also sell bird food!

Winter Mix
6kg: £26 | 12.75kg: £34

Sunflower Hearts
6kg: £22 | 12.75kg: £32

Dried Mealworms
1kg: £19 | 5kg: £69

Suet Balls - Insect Flavour
150 fat balls (13.5kg): £32



To order call us on 0330 133 4708
or visit www.nokular.com/dailyrecord

We'd love to speak with you and hear about your cats!

Terms and conditions: Offer valid whilst stocks last. Goods are sold and supplied by Nokular Limited. We strongly advise weaning your cat(s) on to their new food over the course of 7-10 days. We aim to dispatch orders within 3 working days from date of purchase. Please note that Winter mix contains chopped peanuts. Phone lines open Monday to Friday 9am to 6pm, closed on bank holidays. Please visit www.nokular.com for full T&Cs.



Martin's Social call

MARTIN Compston was among the celebs who helped launch a new London coffee shop aiming to end homelessness.

The cafe is run by Social Bite, which was set up in Edinburgh by Scot Josh Littlejohn - pictured with Martin - and has four other shops north of the Border.

Doc on trial over 84 sex abuse claims

Alleged victim 'would be up on murder charge' if medic had attacked daughter

A WOMAN claimed she would be "up on a murder charge" if a doctor she accuses of carrying out inappropriate examinations had acted in the same way towards her daughter.

BY GRANT McCABE

The 39-year-old mum's allegations against Krishna Singh, relating to when she was a teenager, are among 84 sexual abuse charges faced by the medic, 72.

The witness yesterday told the High Court in Glasgow how Singh had been her GP from a young age until she was about 18.

She claimed seeing him for a check-up about a complaint such as a sore

head or throat would end up him wanting to examine her stomach - which involved her lying down and him "pressing and prodding" about her pant line.

She added: "I did not realise it was such an issue to begin with."

"It was when I got to 16 that it was pointed out to me that it was not a joke."

The mum recalled going to see Singh in 1998 after suffering bad blisters from wearing new boots.

After he treated the injury, the witness said she got the "usual stomach examination".

The woman told the

trial: "I asked why - it was the only time that I did."

"He said it is 'OK, you always have stomach issues, so we will check while here'. It was so off the cuff, so natural."

Prosecutor Angela Gray asked the woman what she thought now about what allegedly taken place.

She replied: "If that was my daughter, I would be sitting in the dock on a murder charge."

Singh, of Airdrie, denies the charges said to have happened between 1983 and 2018, mainly at medical practices in Lanarkshire.

The trial, before judge Lord Armstrong, continues.

Three cats in suspected poisoning

BY GEMMA RYDER

THREE cats have died within 24 hours from suspected anti-freeze poisoning. All of the cats lived just doors from each other on Eden Crescent in Glenrothes, Fife.

The pets started displaying symptoms of vomiting, and loss of coordination and balance, last week.

The Scottish SPCA says that a further cat passed away in similar circumstances a month ago and another cat is still missing.

The animal welfare charity believes they could be potentially dealing with a "deliberate act".

Robyn Gray, Scottish SPCA inspector, said: "This has been an incredibly distressing, sad time for all of the owners involved and our thoughts are with them."

BITLER FOR BOND

Bookies put Scot back in the running as 007



BOOKIES have slashed Gerard Butler's odds to 50-1 in the race to find the next James Bond.

BY RICK FULTON

Despite squashing rumours about succeeding Daniel Craig as 007, claiming that he's too old for the role now, William Hill still thinks that Butler is in with a chance, cutting his odds to 50-1. The current frontrunner is Superman star Henry Cavill, who has seen his odds cut to 2-1, followed by Bridgerton's Rege-Jean Page (11-4).

Other Scots in the market include Outlander's Sam Heughan and The Bodyguard's Richard Madden, most favourably priced at 8-1.



QUIT
Daniel Craig

DOWN YOUR HIGH ST

#THINKWHEREYOU SHOP



SHOP LOCAL WHEN YOU SHOP ONLINE
and get **10% OFF** your first order

Gain access to **1000s** of small retailers selling unique and bespoke products all in one place!

Since Covid-19 local independent shops have had to rely increasingly on online sales.

#THINKWHEREYOU SHOP gives you the opportunity to shop locally and conveniently.



To get 10% off your first order, scan the QR code or visit thinkwhereyoushop.co.uk/record

T&C's apply, see website for details

OK! ROYAL COLLECTOR'S EDITION

ROYAL HOMES AND GARDENS SPECIAL



ON SALE NOW

SECRETS OF THE ROYAL RESIDENCES

- EXPLORE THE CAMBRIDGES' RUSTIC NORFOLK RETREAT
- DISCOVER THE QUEEN'S FAVOURITE HOME
- INSIDE CHARLES AND CAMILLA'S WELSH BOLTHOLE

AVAILABLE IN SHOPS AND AT OK.CO.UK/ROYALHOMESANDGARDENS



Online purchase price excludes P&P. See website for details.

CASH PRIZES TO BE WON EVERY WEEK

ORDER YOUR NEW **Daily Record** **Sunday Mail**

BINGO CARD

CASH PRIZES TO BE WON EVERY WEEK

Daily Record **Sunday Mail**

Bingo!

**NEW
GAME
STARTS
SATURDAY
MARCH
19th**

Visit www.dailyrecord.co.uk/bingo2022
or call 01420 525 503 to get your new card

Phone lines open between 10am and 3pm Mon-Fri. Email reach@webfulfilment.com for any queries.

INSIDE

Equity release can help you in later life

26&27



28

DEAR COLEEN

Husband told us he has a secret child

life.

EDITED BY SALLY McLEAN

DAILY RECORD 16.03.2022

6

OF THE BEST COASTERS
BY ANNA BURNSIDE

Semi-precious stones, Anthropologie, £14



Recycled plastic, Trouva, £14

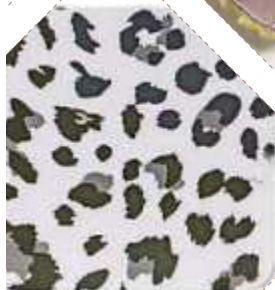

Animal print, the Range, £1.49

BEACH CLEAN

Made from cork and recycled plastic - saved from our oceans.
Set of 4 Coasters



Slate, Dunelm, £4.25



China, John Lewis, £16.95



Pom poms, Next, £8



Why you should NOT bin this letter!



EVERY home has had a letter about Scotland's census. It came in a white envelope addressed to the householder.

Tempted to throw it away? Don't. Every household must complete the census on or before Sunday - there is a fine for those who don't.

But there's more to it than avoiding a criminal record. The census is a crucial piece of official fact finding. To make it as accurate as possible, everyone has to fill it in. This can be done online or you can request a paper version.

What is the census?

The census is a snapshot of the nation, taken once every 10 years. It asks about who lives in the house, what kind of property it is, if everyone is related or married or sharing a flat. There are more sections about everyone's age, sex, health and employment status.

This year, there are questions about what sex people identify as, whether they are trans and their sexual

This Sunday, people in Scotland will fill in the census. **Anna Burnside** finds out why answering the questions can make a genuine difference to lives

orientation. It also asks who has a passport and if anyone has served in the Armed Forces.

How often is there a census?

There has been one every 10 years since 1801. Over the centuries there have been just two missed slots - in 1941, because of World War II and 2021, due to the Covid-19 pandemic.

HOW IT HELPS #2

In south-west Scotland, census info showed how many people were caring for family members. This meant NHS Dumfries and Galloway and the local authority could work with charities and voluntary organisations to tailor its services.

Is the form in the letter?

No, the letter is just to tell you about the census. It has a web address and a code. You go to the website, then enter the code and answer the questions.

Have there been any issues?

Many feminist campaigners

object to the way anyone can choose to identify as a man or a woman on the form.

They say that the guidance for the question "What is your sex?" states the answer you give can be different from the sex given on your birth certificate.

Campaign group Forwomen Scotland said: "This means the data collected will be a mix of sex and 'gender identity'."

The question about national identity has also upset some people. Conservative MSP Stephen Kerr objected to being asked to choose between Scottish or "other British" and suggested the SNP Government would use this to identify sympathisers. The SNP dismissed this as "classic Tory disinformation".

Why is it important?

Census data is used to plan public services, housing and

investment in education, transport, health and social care.

Census data showed that Midlothian would be the fastest growing area of Scotland over the next 25 years. To meet the growing need for services, the council came up with the £15.6million Loanhead Centre.

It brings together Paradykes Primary School, Loanhead Library, Loanhead Medical Practice, a swimming pool and sports centre, plus early learning and childcare services.

About 8000 more people visit the library now it's part of the Loanhead Centre than used it when it was in a standalone building.

What if I don't complete it?

There's a £1000 fine for not filling it in, leaving questions blank or giving false information.

●For help go to www.census.gov.scot or phone 0800 030 8308

HOW IT HELPS #1

In East Ayrshire, the Auchinleck Community Development Initiative used census data to rethink employment help in rural areas. They offered young people training in horticulture, helping them overcome barriers to employment.

ASK AN EXPERT

email s.mclean@dailyrecord.co.uk
with all your consumer queries

I TOOK my puppy to the vet towards the end of last year as he had a skin condition. The vet did not help and, in fact, made the situation worse, confirmed by my new surgeon who has now resolved the issue with the correct treatment. What can I do about this?

TAKING a pet to the vet for treatment is considered a "professional service" in relation to consumer legislation.

As with any professional service, the Consumer Rights Act 2015 requires that the service you receive be provided with reasonable care and skill.

If you are unhappy with the level of the service or the treatment your pet has received for the skin issues, and you can prove that the original treatment was substandard, then you may be able to argue that the vet has not used the required level of reasonable care and skill by law.

Your new vet may be able to provide a report as evidence, highlighting the correct treatment conducted and how this was different to the first course of action.

Due to the fact that your puppy's skin issues have now been resolved, it is not possible for the service to be repeated, so you could ask for a partial refund with consideration towards the level of service you ultimately received from the original vet.

You may also be able to ask the first vet to cover any additional costs that you may have incurred as a result of any substandard service received, provided you can provide evidence of these losses and that you have taken steps to keep them to a minimal.

If you are thinking about raising a formal complaint, we would suggest doing it by letter and signed-for post, or you could send an email requesting a read receipt from the intended recipient as evidence.

You may also wish to report the first vet to a relevant trade body to investigate your concerns. You can report this to the Veterinary Client Mediation Service if the vet is a member of this voluntary



scheme on 0345 040 5834, or by visiting www.vetmediation.co.uk.

The Royal College of Veterinary Surgeons may also be able to help.

More information is available at www.rcvs.org.uk, or by calling 0207 222 2001.

I AM really struggling to afford to heat my home. The cost of energy has increased massively and I have had word from my supplier that costs are going up again and my situation is set to get worse. Can you help?

No household should suffer in fuel poverty or need to ration fuel to get by.

Working in partnership with the Scottish Government, homeheatingadvice.scot delivers the Home Heating Support Fund for Scottish households struggling with energy costs.

The fund seeks to provide financial relief to energy consumers who are experiencing significant financial hardship and strives to provide this support to households regardless of the fuel or payment method used.

If you are struggling with energy costs, or rationing your energy use to afford other essentials, then the fund may be able to offer support.

Individuals can now make applications to the home heating support fund if they have received energy and/or money advice from an accredited agency.

For more information, or to apply, visit www.homeheatingadvice.scot.

OLDER homeowners struggling to cover today's rocketing living costs could enjoy sweet release from money worries by using their property to raise some much-needed cash.

People who own their home can unlock the spare equity in their property and turn it into tax-free cash to spend as they wish.

It's possible by taking out a regulated financial product called an equity release lifetime mortgage.

They are offered by a range of specialist companies, including big names Aviva and Legal & General, and demand is growing as house prices rise, allowing people to access equity.

The average equity release customer raised almost £125,000 last year – the kind of money that can change lives.

You could spend it on doing up your home, taking a holiday, buying a car, funding everyday living costs or helping younger family members. But if you have an outstanding mortgage, you have to clear that first.

Equity release can transform your retirement but taking out a scheme is a big decision and will affect the size of any inheritance you will leave loved ones. So don't rush it.

Make sure you understand what this option is and how it works.

What is equity release?

Equity release schemes allow homeowners aged 55 and over to unlock the capital sitting in their property and put it to work.

The average house is now worth a record £278,123, according to Halifax, handing millions of older homeowners a vast store of untapped wealth.

Many will have bought their house 30 or 40 years ago, and have long since paid down the mortgage, leaving them with heaps of spare equity.

Yet at the same time, many are short of cash to pay their everyday bills, something known as being "asset rich, cash poor".

While most will want to pass on their home to children and grandchildren when they die, they now have another option.

In contrast to a standard mortgage, you do not have any monthly interest payments to make when you take out an equity release lifetime mortgage.

Instead, the interest rolls up and is cleared, along with the money you borrowed, from the proceeds of your house sale when you and your partner either die or go into long-term care. Any property value left falls back into

Record house prices making

Should you unlock the cash in your home after retirement



GET PEACE OF MIND WITH A NO-NEGATIVE EQUITY GUARANTEE

MEMBERS of the Equity Release Council must follow a code of conduct, to give their customers peace of mind.

All products must offer a valuable safeguard known as a no-negative equity guarantee, which means you can never borrow more than your property is worth, regardless of what happens to house prices.

So if prices crash and your debt is greater than the sale value of your property, then neither you nor your family will have to make up the shortfall. And you cannot pass any debt on to your loved ones when you die either.

your estate and can be passed on to your nearest and dearest as an inheritance in the usual way.

How does it work?

The big attraction is that you have the cast-iron right to continue living in your

home for life, provided you choose a plan from a company that belongs to trade body the Equity Release Council (ERC).

You might even be able to move home if you wanted to, subject to certain conditions.

You cannot borrow the full market value of your home, instead it is a percentage based on your age. The older you are, the more you can raise, because as your life expectancy reduces, the equity release company

will not have to wait as long to get its money back. It can therefore pay you more.

So, aged 55, you could typically release a maximum 27 per cent of your property's value. For instance, if it is worth £250,000 you could borrow up to £67,500.

Equity release tends to work best for those age 65 and upwards. By age 75, you can borrow 50 per cent of its value.

You may be able to borrow higher percentages if you have health problems or lifestyle issues, such as smoking heavily. That's because your life expectancy is shorter, which means the equity release company does not expect to wait as long to get its money back.

Last year, 76,000 homeowners tapped into £4.8 billion of housing equity, most of them for the first time.

That is a rise of a quarter on 2020 and with the average house price increasing £25,000 last year, owners can borrow more.

Stephen Lowe, group communications director at retirement specialist Just Group, said demand is up as people who delayed financial decisions in the pandemic

chose to crack on with house prices, his rates and a high between lenders consider using so up in their home.

Where home sum, the average £124,990. Others and kept some ca in what is called

In this case, t sum was £89,78 back for future u in total.

Some plans release money as bit like receiving

Claire Singleto Legal & General demand for e continue to grow

"Homeowners property as an raising cash in re

Take ad

If you're tempte decision, as yo certainly your l



◆ You can access free, impartial advice on any topic from Advice.Scot by contacting 0808 800 9060 or by visiting www.advice.scot
◆ Advice is available to everyone in Scotland, at no cost, regardless of personal circumstance.

g equity release more tempting



with plans. "Rising historically low interest level of competition is tempting people to some of the value tied up," he added. Homeowners took a lump sum amount raised was drawn an initial sum in reserve for later, a drawdown plan. The average upfront sum, with £34,950 held in reserve, making £124,736 available. "We can even allow you to draw a monthly income, a salary." Matt Stirling, chief executive of Home Finance, says equity release will continue in popularity. "We increasingly see their equity release as an acceptable way of financing retirement."

twice first

do not rush your decision. Your home is almost always your biggest asset – and

equity release is complex. Any decision will affect your loved ones, so remember to explain what you are doing and include them in the conversation to avoid shocks later.

Matt Stirling, executive director of later life lending at equity release adviser Age Partnership, says talk to an advisory firm that specialises in equity release, that will have detailed knowledge of all the issues involved.

They should also discuss alternative methods of raising the money you need, such as claiming state benefits, getting help from your family, taking a 25 per cent tax-free lump sum for your pension, finding a part-time job, or downsizing to a smaller property.

"Equity release could affect your eligibility to state benefits and your adviser should check whether this is the case," Matt said.

He says you should involve family and friends in the process, especially your partner and anybody whose inheritance is likely to be affected.

Advisors should offer you a free, no-obligation consultation and clearly set out their fees.

They are obliged to make this clear and a good one will be happy to do so.

Typically, you can expect to pay a flat fee of around £1500 plus VAT.

Beware those who charge a percentage fee, as this could prove more expensive, especially if releasing larger amounts.

Only use a firm that is able to offer advice from the entire range of equity release lenders, rather than simply selling their own product, or products from a limited panel.

Do not be pressured at any point. You must feel free to make a decision in your own time.

The whole process will typically take up to two months.

"This is a long-term commitment so you really need to understand exactly what it involves from start to finish," Matt added.

In an ideal world, there would be no need for equity release. People would simply hand the property down to their kids as an inheritance. These days, that's not always possible, as so many are living longer and struggling to make ends meet in retirement.

So don't be afraid to talk to loved ones. Often, children will encourage parents to go ahead and make the most of their well-earned retirement.

SWITCHING PLANS TO SAVE OVER £50k

EXISTING equity release customers could potentially save more than £50,000 by switching to a cheaper plan as interest rates halve, figures from Age Partnership show.

Yet many do not realise they are free to switch equity release plan after taking one out, wrongly believing they're locked in for life. Rock-bottom

up lifetime mortgage rates, although they are still much lower than in the past."

Many do not realise switching is an option because their original adviser or broker no longer operates.

In some cases, the partner who arranged the original plan has died and the surviving spouse does not understand how it



interest rates and increased competition have slashed the charges of equity release plans from more than six per cent five years ago to about 3.51 per cent today.

Age Partnership customers who switched plan last year will save £51,000 in interest over the average 16-year term of their plan, Matt Stirling, the advisory firm's executive director, said. "They should act fast, as the Bank of England has hiked base rates twice in recent months and this is already pushing

works and the potential saving from switching.

"Many don't involve their other half when taking out equity release, so don't realise the importance of regular reviews," Matt added.

Anyone who has had their equity release loan for 12 months or longer can get a review, and a good adviser should do this free and without any obligation to act. But switching is not right for everyone.

"You will not know until you have the review," Matt added.

“
It'll be a special trip for so many reasons

jennifer russell



PEOPLE always say good things come to those who wait.

Well, it's been well over three years for me to wait to get back to Australia.

I know I've spoken so many times in this column about longing to see my family in Sydney since the coronavirus pandemic hit, but finally I have good news to share with you all.

I've booked my flights and I'm heading down under next month.

I honestly had such an overwhelming feeling of relief and happiness on Sunday when I eventually booked my ticket.

For so long, I've felt so far away from being able to get on a plane and go to Australia, especially because their border only fully opened up last month on February 21.

It's been a long time coming but I honestly now can't wait and can look forward to catching up with my loved ones who I've spent so much time longing to give hugs to - my niece and nephew in particular.

Just last week, while on a video call with them, my nephew shouted that "I'd never actually met him before" and it broke my heart a little hearing him say that.

It's not totally true, as I did meet him when he was only a few weeks old but obviously he doesn't remember this.

He's too young to remember seeing me in person and not just on a screen, but all that will be a thing of the past in a few weeks' time.

There's only so many things you can do on a video call with kids.

I can't wait to actually jump around on their trampoline with them, go swimming and for them to show me their new house and meet their friends.

Of course, I'll be delighted to see their parents as well, my brother and sister-in-law, but we all know it's time with the kids that matters most.

It's also my fiance's first time meeting my family.

When we got together four years ago, neither of us had any idea it would be four years and an engagement later and he's never met my oldest brother, aunt, cousin and the rest of the family.

It'll be a special trip for so many reasons, and I'm very lucky to be able to do it.

I feel blessed. We've all gone through so much over the last few years and I most certainly don't take any of it for granted.

My week has been made so much brighter and hopefully this really is the light at the end of the tunnel in our fight against the pandemic.

What a relief - and one for you all reading this as well, as maybe I'll finally stop writing about it!

Dear Coleen..



THE STRAIGHT-TALKING PROBLEM PAGE

email dearcoleen@dailyrecord.co.uk

I'VE LET MYSELF GO AND HAVE NO MOTIVATION

Dear Coleen

OVER the past couple of years, I've really let myself go but I don't seem to be able to do anything about it.

I'm a woman in my 40s and previously felt pretty positive about myself. However, since the pandemic I've stopped exercising, stopped eating healthily, don't care much about my appearance and everything seems like an effort.

I've gained quite a lot of weight, which my husband has noticed and commented on, and I have little enthusiasm for things.

How can I get out of this rut?



Coleen says

I THINK you need to focus less on the weight and tackle your mindset. Many people have got into a rut during the pandemic because of the forced isolation and the stress and it might take time to feel as strong and optimistic as you did before, so don't be too hard on yourself.

It's easy to feel overwhelmed, so the thing is not to try to do everything at once or have big ambitious goals - start with small things you know you can achieve.

That might be getting outside and having a 10-minute walk every day, making something healthier to eat every morning or taking an hour a day - no matter what else is going on - just for yourself.

But be disciplined about it. It's about creating a new routine for yourself and replacing negative habits with positive ones.

But the thing with feeling low or depressed is that it takes a while to reach that point, so it also takes time to re-emerge.

You don't say if your husband's comments about your weight were critical and judgmental but adopting a healthier, more positive lifestyle is something you can do together.

Hubby confessed he has secret four year old son

Dear Coleen

I'VE been married for 20 years and we have one daughter together. For the most part, our relationship has been very good. However, it recently came out that my husband had an affair about five years ago and has a four-year-old son.

He confessed a few months ago after both his parents died. I think he'd been struggling with the guilt and wanted to come clean and start again.

The affair was over some time ago, so we had lots of therapy and we've managed to stay together.

The major stumbling block is the arrangements over his son. While I'm OK with him seeing his child, I don't feel that I'm ready to be involved. Our daughter is 16 and feels betrayed and angry and doesn't feel ready for a relationship with her brother either.

I think now he's confessed, my husband just expects everything to just fall into place and for us to welcome his son with open arms. I hope this doesn't sound cold and unfeeling but I think he's expecting too much of us, as we're still reeling from what's happened. Can we move on?



“ He expects everything to just go back to being normal ”

Coleen says

I THINK he's expecting too much at the moment, as you're still clearly struggling from the fallout of his confession and coming to terms with the fact he has another child in his life.

The most important thing is you're not stopping him from having contact with his son, who's done nothing wrong and deserves to have a father in his life.

I'm sure that after having therapy your husband must understand he can't just put a plaster over this - it's going to take time to find a way through it and he needs to be patient with you and your daughter and accept how you feel.

Some partners never get over an affair, let alone when there's a child involved, but I do believe you can move on if you want to. It'll take time, probably more therapy and complete honesty from everyone.

I also think it's important to have boundaries around him seeing his son that you're OK with, such as where they meet, if the boy's mother is around and so on.

Your husband needs to be honest and reassuring when it comes to this.

YOU SAY

“ I'D like to reply to the woman who is affected by upsetting world events and can't sleep at night (Dear Coleen, March 3). You are not alone - I worry about everything and it eats away at me. ”

IS IT RISKY DATING YOUNG GUY FOR FUN?

Dear Coleen

I'M A woman in my 40s and got divorced a few years ago. I don't have kids and I'm not in a serious relationship at the moment.

I work with a guy I find very sexy and it's clear he's interested in me, too, but he's only 28.

I think about him a lot and what it would be like to sleep with him but I don't want either of us to get hurt. If I could have fun without any risks, I wouldn't think twice.

But there's part of me that worries it's a waste of time and I should only be considering older men, so there's a chance of a proper relationship.

I'd love to hear your thoughts.

Coleen says

EVEN if you started dating an older guy, there are no guarantees the relationship will



last. No one has a crystal ball at the start of any relationship.

I think you need to work out what you want - if right now it's fun and no strings, then fill your boots. Why not?

Just bear in mind that if you fall out, it might make things tricky at work.

Personally, getting involved with a younger guy isn't for me - I've no desire to go to bars or

clubs or hike up mountains (and whatever else young guys do these days).

Yes, it's a huge ego boost if someone younger finds you attractive and pays you attention but that's enough for me. If you do get involved with this guy, just have realistic expectations and be honest at the start about what each of you wants from a relationship.

record tv

EMMERDALE

STV, 7.30pm

DAWN hides Alex's blackmail from Harriet and Billy as she struggles to share in their excitement over the adoption.

Dawn's deceit ramps up a notch when she attempts to steal from Home Farm in order to pay Alex's debts.

Manpreet puts on a brave face as she nervously awaits Meena's plea hearing.

Amelia reluctantly tells her concerned family about her encounter with Noah but is left embarrassed when Kerry intervenes.



STUNNED Abi sees Kevin at the hospital

CORONATION STREET

STV, 8pm

AFTER seeing Abi's story in the Gazette, Debbie demands answers, assuming the baby to be Kevin's.

But Abi hurries out, explaining the baby is having an operation. As she later waits for news, she's stunned to see Kevin in the hospital corridor.

When Aggie finds Ed perusing the racing pages in the hope of winning £10k, she's horrified to realise Grace's threats could trigger his gambling.

Amy tells Jacob she'll try to swerve her parents so they can meet up later.

EASTENDERS

BBC1, 7.30pm

THINGS are tense at the Taylor household as Mitch tries to find somewhere to stay and Bailey pleads with Keegan to intervene,

unaware of how much he is struggling. Vinny and Kat rally as Keegan opens up.

Jean prepares for another lavish date with Harvey, which gives Tommy a thought - is his nan the money thief? He decides to confront her.

Later, Tommy approaches Billy and asks if he can be his apprentice, insisting that he didn't steal from Kat.



STRUGGLE Keegan

DON'T MISS SATURDAY MAGAZINE



Your favourite weekend magazine has celebrity interviews, real-life stories plus recipes, fashion and a brilliant TV guide



Home truths

COUNCIL HOUSE SWAP

Channel 5, 9pm

MILLIONS of council house tenants use swap websites - a bit like online dating but for homes.

It's a competitive world, where people who want to live elsewhere can swap anywhere across the UK.

But there's a catch. Once they've found their ideal home, they have to convince the person living there to

move into the house they are vacating. The result is this entertaining series, as everyone judges absolutely everything that's on offer, from the wallpaper to the street bins.

Swappers have to manage and perform the entire process on their own - taking on the role of estate agent... and an extra judgy one.

Beth, one of the swappers in this episode, says: "I've viewed some really horrific places. Mattresses on the floor, dirty plates, dirty knickers

on the floor. Honestly I've seen it all, it's like a joke."

The mum of four wants to leave suburban Mitcham in Surrey for somewhere more rural, since her son Alfie is literally climbing the walls.

But she's so picky, will she ever be able to feel at home anywhere else? Then it gets complicated when she finds herself in a potential multi-swap situation.

Elsewhere, Andy and Marie

PICK of the DAY

McBain, from Worthing, West Sussex, want an extra bedroom so their two 20-something daughters no longer have to share.

They need to upsize, while finding someone who is equally keen to downsize. The main problem seems to be Marie's loathing for anything that's been decorated with gloss paint.

It all makes for strangely compelling viewing.



CLUNKY Okorie and Brenda

KATE & KOJI

STV, 9pm

IF YOU think Mrs Brown's Boys is uproariously funny, you'll probably like this. If not, it might be best to switch over. Centred on an old-fashioned seaside cafe, it's all canned laughter and set-up gags, with the jokes focused on the clash between the old and the new.

Brenda Blethyn plays Kate, a working-class woman with strong, often dated opinions, while Okorie Chukwu has taken over the role from Jimmy Akingbola of an asylum-seeking African doctor.

The pair strike up a friendship - he

gets free food, while customers queue round the block for a free GP consultation. Cue gags about doctor waiting lists and the bad treatment of asylum seekers.

This aims to make comment on current social issues but clunky plot lines mean it doesn't always hit the mark.

Blake Harrison plays Kate's nephew "Medium", while Barbara Flynn is Councillor Bone, Kate's lifelong arch enemy.

In this series, Kate and Medium are up for an award, Kate and the councillor are still feuding and we're still waiting for laughs...

THIS IS MY HOUSE FOR RED NOSE DAY

BBC1, 8pm

A CELEBRITY edition of this baffling game show, which sees four people all claim to own the same house. Usually they all pretend to be the same person as well, but with famous faces taking part, that ship has sailed.

Cameras will snoop around a luxury four-bedroom house, while the celebs try to convince a panel that it belongs to them.

Honing their skills of persuasion are former boxer Ricky Hatton, Dragon Deborah Meaden, singer-songwriter

Claire Richards, and TV presenter Rob Rinder, who all maintain that "this is MY house".

The panel is a starry affair for this special too. Claudia Winkleman, Chris Eubank, Harry Hill and Nina Wadia must deduce who is telling the truth and which three are lying through their teeth.

No doubt there will be clues and red herrings around the house but it likely won't be as easy as a pair of boxing gloves or a judge's gavel lying around.

Through The Keyhole, without Keith Lemon. Win, win.



GUESS WHO Chris, Claudia, Harry and Nina enjoy a snoop

BBC ONE

6.00am Breakfast News headlines.
9.15 Morning Live Magazine.
10.00 Crimewatch Live Appeals.
10.45 Caught Red Handed A car thief comes face to face with the vehicle's owner. (R)
11.15 Homes Under the Hammer Properties in Wallasey, Ilkeston and Salford. (R)
12.15pm Bargain Hunt Members of rock bands the Darkness and Feeder compete. (R)
1.00 BBC News at One; Weather
1.30 Reporting Scotland
1.45 Doctors A struggling Emma makes a bad impression.
2.15 Politics Scotland A round-up of political news.
3.00 Shakespeare & Hathaway – Private Investigators Lu and Frank must clear the Queen's name. (R)
3.45 The Repair Shop The artisans work on Victorian lamps and a jewellery box.
4.30 Bridge of Lies Gameshow.
5.15 Pointless Quiz show.
6.00 BBC News at Six; Weather
6.30 Reporting Scotland

BBC TWO

6.30am Escape to the Country (R)
7.15 The Repair Shop (R)
8.00 Sign Zone: Gardeners' World Planting trees. (R)
9.00 BBC News Double bill.
10.00 BBC News Headlines.
11.15 Politics Live Reports.
1.00pm Ready Steady Cook (R)
1.45 Eggheads Quiz show. (R)
2.15 Put Your Money Where Your Mouth Is Eric Knowles faces Chuko Ojiri at an auction in Colchester. (R)
3.00 The Heights Lottie explains her response to Ryan. (R)
3.30 Murder, Mystery and My Family Sasha Wass and Jeremy Dein re-investigate the killing of a German woman. (R)
4.15 The Real Marigold Hotel Henry revisits the cricket ground where he made his last overseas broadcast. (R)
5.15 Flog It! Revisiting some of the locations from the series. (R)
6.00 Richard Osman's House of Games With Jen Brister, Kelvin Fletcher and Ian Moore.
6.30 Lightning Comedian Zoe Lyons hosts the quick-fire quiz.

STV

6.00am Good Morning Britain Morning magazine featuring a lively mix of news and current affairs, plus lifestyle features.
9.00 Lorraine Entertainment and the latest fashion news.
10.00 This Morning A mix of celebrity chat, features, advice and competitions. Including Local Weather.
12.30pm ITV News; Weather
12.40 STV News; Weather
12.50 LIVE STV Racing: Cheltenham Festival Ed Chamberlin and Francesca Cumani present the second day of the prestigious festival, including feature race the 3.30 Champion Chase, plus races at 1.30, 2.10, 2.50 and 4.10.
4.30 Tipping Point: Best Ever Finals Compilation of some of the most dramatic endgames from the quiz show hosted by Ben Shephard.
5.00 The Chase Bradley Walsh presents as contestants Jill, James, Malcolm and Kat work as a team to take on ruthless quiz genius the Chaser and secure a cash prize. (R)

CHANNEL 4

6.00am Countdown (R)
6.40 Cheers Double bill. (R)
7.35 Everybody Loves Raymond Triple bill of the sitcom. (R)
9.00 Frasier Triple bill. (R)
10.30 Ramsay's Kitchen Nightmares USA The chef is in California. (R)
11.25 Channel 4 News Summary
11.30 Coast vs Country (R)
12.30pm Steph's Packed Lunch
2.10 Countdown Gameshow.
3.00 A Place in the Sun Scarlett Douglas helps a couple to find a new home in Valencia. (R)
4.00 A New Life in the Sun A couple of bike lovers launch a new business in Spain. (R)
5.00 Four in a Bed A visit to the Greyhound Hotel in Cromford, Derbyshire.
5.30 Fame in the Family The diners guess who is related to Neil 'Razor' Ruddock.
6.00 The Simpsons Homer is humiliated by a wild bear. (R)
6.30 Hollyoaks Zara and Tony prepare for their debate, but could a blast from the past ruin things for Zara. (R)

CHANNEL 5

6.00am Milkshake! Children's TV.
9.15 Jeremy Vine Discussion.
12.15pm George Clarke's Build a New Life in the Country Relocating to Scotland. (R)
1.10 5 News at Lunchtime
1.15 Home and Away Mia has the brilliant idea of getting married to Ari in prison.
1.45 Neighbours See 6.00pm.
2.15 FILM A Stranger in My Home (2020, 12) Premiere. A man hires a woman to house-sit for him, but she ends up posing as his new girlfriend with no intentions of leaving. Thriller, starring Anna Marie Dobbins. ★★★
4.00 Filthy House SOS Richard and Brennan come to the aid of a father in Keighley. (R)
5.00 5 News at 5 Headlines.
6.00 Neighbours Amy is still waiting for an answer from Ned, but his tryst with Harlow weighs on him. (R)
6.30 Eggheads Jeremy Vine asks the questions as Uddingston pub quiz team the Windmill Regulars take on the experts.

Today's TV previews are on the previous page

film ratings

★★★★★ Brilliant
 ★★★★ Very Good
 ★★★ Good
 ★★ Average
 ★ Bad

(R) Repeat



GET THE LATEST NEWS STRAIGHT TO YOUR INBOX

SIGN UP NOW AT dailyrecord.co.uk/newsletters



7

7.00 The One Show With Alex Jones and Jermaine Jenas.
7.30 EastEnders Keegan is frustrated with himself for not picking up on Gray's abuse, Mitch tries to find somewhere to stay and Tommy suspects the thief is close to home.

7.00 Doctors A struggling Emma makes a bad impression with someone important and Jimmi reaches out to Asif. (R)
7.30 Rick Stein's Cornwall The chef champions the food, history, music, art and culture of the county. (R)

6.00 STV News at Six; Weather The latest regional reports.
6.30 ITV Evening News; Weather
7.30 Emmerdale Dawn is under immense pressure, Manpreet puts on a brave face, and a vulnerable Amelia is left embarrassed.

7.00 Channel 4 News The latest news headlines, featuring in-depth interviews and analysis of political developments and current affairs. Plus, the day's leading sports stories and up-to-the-minute weather reports.

7.00 The Gadget Show Georgie Barrat and Jon Bentley go head to head to find out if a soundbar can cut it against speakers dotted around the room for the ultimate surround-sound experience; 5 News Update

8

8.00 This Is My House for Red Nose Day With Claudia Winkleman, Chris Eubank, Harry Hill and Nina Wadia.
8.30 The Repair Shop Jay Blades and the team restore more family heirlooms and treasured items to their former glory.

8.00 Your Body Uncovered with Kate Garraway Kate meets a singer who has been delaying treatment for a thyroid nodule for fear it may damage her voice, and a woman who has been plagued by agonising gallstone attacks.

8.00 Coronation Street Abi anxiously awaits the outcome of her baby's operation, Amy is thwarted in her efforts to spend time with Jacob, Michael confronts Grace, and Adam gets drunk and chats up a girl to blot out his misery.

8.00 Kirstie and Phil's Love It or List It Kirstie Allsopp and Phil Spencer meet supply teacher Sue and builder Roy in Poole, Dorset, who cannot agree whether to sell their four-bedroom chalet bungalow or renovate instead. (R)

8.00 Police Interceptors Dan Machin and Jim Campin manage to track down a suspected drunk driver, who runs at Jim holding a knife and Dan is left with no choice but to use his Taser on him; 5 News Update

9

9.00 Interior Design Masters with Alan Carr The contestants are sent to Wotton House, a grand hotel in the Surrey Hills, where they must each make over one of the nine bedrooms on a theme of British eccentricity.

9.00 Great British Menu The chefs from the South West compete. For mains, one chef takes inspiration from Radio 4's Desert Island Discs, and another pays homage to William and Kate's Wedding. Presented by Andi Oliver.

9.00 NEW Kate & Koji Kate is set to be rewarded for her work during the pandemic, but she discovers Councillor Bone is going to present the award.
9.30 Bradley & Barney Walsh: Breaking Dad The actor and his son hit the road. (R)

9.00 Michael Mosley: Who Made Britain Fat? Documentary in which journalist Michael Mosley delves into why politicians seem powerless to reverse – or even halt – the steep rise in the number of Brits living with obesity.

9.00 NEW Council House Swap Documentary about tenants in social housing across the UK looking to exchange homes. In the first edition, mum-of-four Beth wants to trade Mitcham in Surrey with somewhere more rural.

10

10.00 BBC News at Ten
10.25 Reporting Scotland
10.35 Mood Sasha thinks she has found a best friend in Carly and her life is on the up – until she makes a decision she never thought she would. Drama, with Nicole Lecky. (R)

10.00 The Office The staff are in a charitable mood on Red Nose Day, with Gareth hopping everywhere, quiet accountant Keith doing his best Ali G impersonation and Dawn selling kisses for a pound. (R)
10.30 Newsnight With Kirsty Wark.

10.00 ITV News at Ten; Weather The major stories of the day.
10.30 STV News; Weather
10.40 Scotland Tonight; Weather Current affairs show that tackles the issues behind the headlines from a Scottish perspective.

10.00 Naked Attraction A 28-year-old nature lover and a 48-year-old building boss each choose a date after seeing what their potential partners have to offer on a purely physical level. Hosted by Anna Richardson.

10.00 FILM Rambo: Last Blood (2019, 18) Premiere. John Rambo must confront his past and unearth his ruthless combat skills to exact revenge in one final mission. Action thriller sequel, starring Sylvester Stallone. ★★★

11

11.25 Scottish Questions Scottish ministers face questions.
11.55 Debate Night Topical debate on the big issues affecting Scotland. Members of the public put their questions to a panel of politicians and other public figures. (R)

11.15 Unspun World with John Simpson The BBC's world affairs editor reflects on the week's global news stories.
11.40 Rock Till We Drop Rehearsals intensify so that the bands can perfect the tracks they have learnt so far. (R)

11.05 Peston Political magazine show, featuring interviews with MPs, guests and cultural figures. Including updates from social media taking in perspectives from viewers, experts and key players throughout the programme.

11.05 Sex Actually with Alice Levine Alice explores the world of bondage, domination and sadomasochism, meeting people whose appetite to play with power and pain is about much more than just whips, chains and latex. (R)

11.45 FILM Rise of the Footsoldier 4: Marbella (2019, 18) Fresh out of prison, a former nightclub owner heads to Marbella to seek revenge against the man who put him away. Action comedy, starring Craig Fairbrass. ★★★

12

midnight

12.55am Tom Daley's Hell of a Homecoming. The Olympic diver takes on an endurance challenge as he rows, cycles, swims and runs his way from Stratford to Plymouth. (R) **1.55** The Graham Norton Show. Highlights. (R) **2.45** Weather for the Week Ahead **2.50-6.00am** BBC News

12.40am Sign Zone: Extraordinary Portraits. Celebrated portrait artists create likenesses of members of the public. (R) **1.10** Sign Zone: Stanley Tucci: Searching for Italy. From Naples and the Amalfi Coast. (R) **1.55** Sign Zone: Great Coastal Railway Journeys (R) **2.25-6.30am** This Is BBC Two

12.05am Home Shopping 3.00 Bling. Gok Wan meets Simone and Mara, who have a very special commission for Nikki on the Make counter, while Emma visits David on the Fix counter in the hope he will make her husband's day. (R) **3.50** Unwind with STV **5.05-6.00am** Tipping Point (R)

12.10am Ramsay's Kitchen Nightmares USA (R) **1.05** 24 Hours in A&E (R) **2.00** The Simpsons (R) **2.25** FILM Area 51 (2015, 15) Sci-fi thriller, starring Reid Warner. ★★★ **4.00** Location, Location, Location (R) **4.55** George Clarke's Old House, New Home (R) **5.50-6.00am** Find It, Fix It, Flog It

1.20am The 21.co.uk Live Casino Show **3.20** The Queen's Guards: A Year In Service. Rehearsals for the Queen's birthday parade. (R) **4.10** Get Your Tatts Out: Kavos Ink. Documentary. (R) **5.00** Wildlife SOS (R) **5.20** House Doctor (R) **5.45** Peppa Pig (R) **5.50-6.00am** Pip and Posy (R)

ITV2 Freeview 6

6.00am Dress to Impress **7.00** The Ellen DeGeneres Show **8.00** You've Been Framed! Unstoppable! **9.00** SecretCrush **10.00** Dress to Impress **11.00** Love Bites **12.00noon** Supermarket Sweep **1.00** Tipping Point: Lucky Stars **2.00** Rolling in It **3.00** The Ellen DeGeneres Show **4.00** The Masked Singer US **5.00** You've Been Framed! & Fabulous!

6.00 **Celebrity Catchphrase** Tony Bellew, Kelly Osbourne and Dan Walker guess the phrases hidden in animated clues.

7.00 **Superstore** Double bill. Dina asks for a demotion; Cheyenne goes into labour.

8.00 **Bob's Burgers** Double bill. Louise gets her bunny ears stolen by a bully; the kids decide to go trick-or-treating.

9.00 **Family Guy** Five episodes.

11.30 **American Dad!** Animated comedy.

12.00m't **American Dad!** **12.25** Bob's Burgers. Comedy. **1.25** Superstore **2.20** Hey Tracey! **3.10** Unwind with ITV **3.30-6.00am** Teleshopping

DAVE Freeview 19

6.00am Teleshopping **7.10** Sin City Motors **8.00** Timber Kings **9.00** Storage Hunters UK **10.00** Top Gear **11.00** World's Most Dangerous Roads **12.00noon** Red Bull Soapbox Race **1.00** Border Force: America's Gatekeepers **2.00** World's Most Dangerous Roads **3.00** Rick Stein's Secret France **4.00** Red Bull Soapbox Race **5.00** Rick Stein's Secret France

6.00 **Taskmaster** Gameshow.

7.00 **Richard Osman's House of Games**

7.40 **Room 101** With Claudia Winkleman.

8.20 **Would I Lie to You?** With Claudia Winkleman and Clive Anderson.

9.00 **QI** Sandi Toksvig quizzes the panel.

10.00 **Outsiders** It's the Outsiders' last day living together in the wild.

11.00 **Have I Got a Bit More 2019 News for You** Extended compilation.

12.00m't Hypothetical. Comedy game show. **12.40** QI **1.20** Would I Lie to You? **2.00** Live at the Apollo **2.45** This Country **4.00-6.00am** Teleshopping

E4 Freeview 13

6.00am Hollyoaks **7.00** Ramsay's Kitchen Nightmares USA **9.00** Married at First Sight Australia **10.30** The Big Bang Theory **11.00** Young Sheldon **12.00noon** Brooklyn Nine-Nine **1.00** The Big Bang Theory: four episodes **3.00** Young Sheldon **4.00** Brooklyn Nine-Nine **5.00** The Big Bang Theory: double bill

6.00 **The Big Bang Theory** Double bill.

7.00 **Hollyoaks** A protest turns sour.

7.30 **Married at First Sight Australia** The newlyweds start their honeymoons.

9.00 **Teen First Dates** Patrick from Portsmouth, is set up on a date with Olly.

10.00 **Celebrity Gogglebox** Hostile Planet, Big Brother: Best Shows Ever and EastEnders are appraised.

11.05 **Gogglebox** TV opinions.

12.10am First Dates **1.15** Married at First Sight Australia **2.45** Teen First Dates **3.40** Below Deck: Mediterranean **4.30** Ramsay's Kitchen Nightmares USA **5.20-6.00am** Mike & Molly

VARIATIONS

BBC SCOTLAND **7.00pm** Getaways **7.30** Style Fixers **8.00** This Farming Life. The Frasers have teething problems at their new farm shop. **9.00** The Nine **10.00** The Scotts **10.30** Debate Night **11.30pm-12.00m't** David Wilson's Crime Files

BBC ALBA **6.00am** Alba Today **5.00pm** Su Pic (Peek Zoo) **5.10** Bing **5.15** Bing **5.25** Gudrun - A' Bhana-phrionnsa Lochlannach **5.30** Lon le Linda **5.45** Peataichean/Pets **5.55** Stoiridh **6.00** Kung Fu Panda **6.25** Damhan & Durrig/Pipas & Douglas **6.30** @12 **6.35** Saidheans Sporsail (Backyard Science) **7.00** Turas a' Bhradain **7.30** SpeakGaelic **8.00** An La (News) **8.30** An Cuan Sgith (The Minch) **9.00** Eilean Chanaigh (Summer on Canna) **10.00** OMC! **10.30** Na Gleidheadairean (The Animal Keepers) **11.30** Na Trads: An Tobar **12.00m't-6.00am** Alba Today

ENGLAND As BBC1 except: **1.30-1.45pm** Regional News; Weather **2.15** Shakespeare & Hathaway - Private Investigators **3.00-3.45** Escape to the Country **6.30-7.00** Regional News. Local headlines; Weather **10.25-10.30** Regional News; Weather **11.25** Tom Daley's Hell of a Homecoming **12.25am** The Graham Norton Show **1.20-6.00am** BBC News

ITVBe Freeview 28

7.00am The Real Housewives of Cheshire **8.00** Buying and Selling **9.00** LittleBe **12.00noon** Best Cake Wins **12.30** The Real Housewives of Potomac **1.25** The Real Housewives of Cheshire **2.25** The Only Way Is Essex **3.10** Little Women: LA **4.05** The Real Housewives of Beverly Hills **5.00** The Real Housewives of Orange County. Vicki and Kelly argue again.

6.00 **Masters of Flip** An old farmhouse.

7.00 **Buying and Selling** A retired couple.

8.00 **Dinner Date** Shakir from Liverpool is given five menus from five potential dates.

9.00 **Botched: Most Outrageous Patients**

9.30 **Botched: Most Outrageous Rejects**

10.00 **Botched** Terry Dubrow helps a fitness model achieve her dream.

11.00 **Bridezillas** Shannon is unhappy with her bridesmaid dresses.

11.55 **The Only Way Is Essex** Mario and Little Chris try to save their friendship.

12.45am Unwind with ITV. Daily escape. **1.00-7.00am** Teleshopping

DRAMA Freeview 20

6.00am Teleshopping **7.00** Brush Strokes **7.40** Hetty Wainthropp Investigates **8.35** The Bill **9.35** Classic Holby City **10.55** Classic Casualty **12.00noon** The Bill **1.00** Classic EastEnders **2.15** Hetty Wainthropp Investigates **3.20** Lovejoy **4.20** Peak Practice **5.20** Brush Strokes

6.00 **Are You Being Served?** Sitcom.

6.40 **Last of the Summer Wine** Double bill.

8.00 **The Last Detective** Davies investigates the murder of a former soldier, but finding anybody within his old artillery regiment willing to give information proves a difficult task.

9.40 **New Tricks** The team reinvestigates a murder and discovers new evidence that casts doubt on the guilty verdict passed on the man executed for the crime.

11.00 **Silent Witness** The chief suspect of a murder gives himself up, leaving an unconvinced Sam to prove his innocence.

1.15am Kavanagh QC **2.45** Monarch of the Glen **4.00-6.00am** Teleshopping

MORE4 Freeview 18

8.55am A Place in the Sun **10.35** Find It, Fix It, Flog It **12.35pm** Heir Hunters **1.35** Four in a Bed **4.15** The Hotel Fixers **4.50** Find It, Fix It, Flog It **5.55** Car S.O.S

6.55 **Escape to the Chateau: DIY** Erin and JB launch their chateau business by opening it up to the locals.

7.55 **Devon and Cornwall** Jess Harris and Charlotte Whyte welcome diners aboard their floating restaurant.

9.00 **Secrets of the Royal Gardens** The gardens of private royal houses across Britain, including Sandringham Estate.

10.00 **Catching a Killer** Thames Valley Police's investigation into the disappearance of 31-year-old Natalie Hemming in 2016, following the case through to the arrest and conclusion.

11.50 **24 Hours in A&E** A 23-year-old builder is rushed in after an accident.

12.55am Secrets of the Royal Gardens **1.55** Location, Location, Location **3.00-3.45am** Food Unwrapped

NORTHERN IRELAND As BBC1 except: **1.30-1.45pm** BBC Newsline; Weather **2.15** Shakespeare & Hathaway - Private Investigators **3.00-3.45** Escape to the Country **6.30-7.00** BBC Newsline; Weather **10.25** BBC Newsline; Weather **10.35** Nolan Live **11.35** The Fast and the Farmer-ish **12.05am** Mood **12.55** The Graham Norton Show **1.45-6.00am** BBC News

NORTHERN IRELAND As BBC2 except: **10.00-10.30pm** Spotlight **11.15** Crime NI **11.55** The Office **12.25am** Unspun World with John Simpson **12.50-1.10am** BBC News

BORDER As STV except: **12.40pm** ITV News Border **12.50-4.30** **LIVE** ITV Racing: Cheltenham Festival **6.00-6.30** ITV News Lookaround. Headlines; Weather **10.30** ITV News Border; Weather **10.45** Peston **11.40** Paul Sinha's TV Showdown **12.25-3.00am** Home Shopping **3.50-5.05am** Unwind with ITV

UTV As STV except: **12.40pm** UTV Live **12.50-4.30** **LIVE** ITV Racing: Cheltenham Festival **6.00-6.30** UTV Live; Weather **10.30** UTV Live; Weather **10.45** Peston **11.40** Paul Sinha's TV Showdown **12.25-3.00am** Home Shopping **3.50-5.05am** Unwind with ITV

BBC3 Freeview 23

7.00pm **MasterChef Australia** Contestants go up against their own professional guest chefs.

7.55 **The Catch Up** The day's news.

8.00 **Computer Says No** Daniel Henry dives into the world of algorithms and computer-automated hiring.

8.50 **Becoming - Nathan Drake** Tom Holland reveals all about taking on the iconic character in Uncharted.

9.10 **Gassed Up** Rapper Mist takes on entrepreneur Spencer Matthews.

10.00 **The Fast and the Farmer-ish** Teams from Northern Ireland and Scotland compete in this semi-final.

11.00 **This Country** A one-off special investigating the fallout from Kerry Mucklowe's criminal activity.

11.45 **Tonight with Target** With D Double E, Stylo G and Joy Crookes.

12.35am Gassed Up **1.20** The Fast and the Farmer-ish **2.20** Tonight with Target **3.10-4.00am** This Country

BBC4 Freeview 24

7.00pm **Fred Dibnah's World of Steam, Steel and Stone** The steeplejack's love of restoring engines and chimneys.

7.30 **Canal Boat Diaries** The Victorian village of Saltaire.

8.00 **Secret Life of Farm Animals** The behaviour of farm animals, beginning by focusing on sheep.

9.00 **Princess Margaret: The Rebel Royal** Part one of two. Documentary profile of the Queen's sister.

10.00 **Undercover OAP: The Mole Agent - Storyville** The story of an 83-year-old who went undercover in a Chilean nursing home.

11.25 **Takaya: Lone Wolf** Following seven years in the life of a lone wolf.

12.25am Canal Boat Diaries **12.55** Fred Dibnah's World of Steam, Steel and Stone **1.25** Secret Life of Farm Animals **2.25-3.25am** Princess Margaret: The Rebel Royal

5 USA Freeview 21

6.00am TJC **9.00** NCIS **11.55** Entertainment News **12.00noon** Law & Order **1.55** Entertainment News **2.00** Law & Order **3.55** Entertainment News **4.00** Law & Order. Drama.

6.00 **NCIS Triple bill.** The team investigates when a fellow agent's burnt body is discovered; Gibbs is held captive by Paloma Reynosa; the team gets close to tracking down a Mexican drug kingpin.

9.00 **Crossing Lines** The team is called out to Lausanne in Switzerland to handle a hostage situation.

10.00 **Law & Order: Special Victims Unit Triple bill.** A businessman is stabbed; a girl's body is found outside a church; a woman's body is found at an industrial laundry.

12.55am Law & Order: Special Victims Unit **1.50** Private Eyes **3.35** 999: Criminals Caught on Camera **4.00-6.00am** Teleshopping

PRIDE OF SCOTLAND

DO YOU KNOW AN OLIVIA?



NOMINATE YOUR HERO TODAY

prideofscotland.org/nominate



stars.



record readers.

Aries March 21-April 20
 IF YOU aren't hiding your feelings then there is probably someone else who is hiding the truth from you. You're surprised by the way someone has so easily swept an important issue under the carpet. An important matter is not being addressed and you want to get to the bottom of it.

For more call **0905 789 4171** (80p/min + network access charge)

Taurus April 21 - May 21
 SOCIAL activities and situations will be pleasant enough. Friends and colleagues will inspire you as they talk about their interests and share their hopes for the months to come. You have goals of your own and listening to a friend's ambitions will help you push past self-imposed limitations.

For more call **0905 789 4172** (80p/min + network access charge)

Gemini May 22 - June 20
 YOU like to feel you can rely on your intuitive responses. At the same time, you always question what you see, hear and experience and will take an analytical view of what is going on. By being aware of your thoughts and feelings you can embrace both imagination and practicality.

For more call **0905 789 4173** (80p/min + network access charge)

Cancer June 21 - July 22
 YOU will be asked to share your views but the moment you do so, someone will question why you feel this way and wonder why you can't agree with them instead. There are times when it is sensible to keep quiet about your opinions, even when you are being asked to share them.

For more call **0905 789 4174** (80p/min + network access charge)

Leo July 23 - August 22
 IT'S A good time to set up a savings plan. You seem to instinctively know the best way to grow your money. A legal or financial matter you're mixed up in will go better than you had dared expect. You knew it wasn't going to be easy and it will be a relief it's resolved to your satisfaction.

For more call **0905 789 4175** (80p/min + network access charge)

Virgo Aug 23 - Sept 22
 A GROUP is doing some great work refurbishing donated items and getting these to the people who need them. A different challenge altogether is now presented. You may be asked to join a committee to look at new problems and decide the best way to approach these.

For more call **0905 789 4176** (80p/min + network access charge)

Libra Sept 23-Oct 23
 YOUR patience is about to be tried to its limit. You can't understand why a housemate seems to want to stir up unnecessary conflict. You aren't in the mood to argue. In fact one of your greatest strengths is the ability to maintain harmony, even when other people are irritable.

For more call **0905 789 4177** (80p/min + network access charge)

Scorpio Oct 24 - Nov 22
 A LEGAL issue has been causing you a lot of stress and tension. In addition to this there has been an array of problems that have been discovered. You will be closely following developments on a news story because this will affect your life or community in some way.

For more call **0905 789 4178** (80p/min + network access charge)

Sagittarius Nov 23 - Dec 21
 SOMEONE in the family is spending cash with no thought of tomorrow. Disputes in the family over money mar your day. Do you intend to do some travelling soon? If so, be careful who you tell your plans to as someone will invite themselves along, even though you will prefer to travel alone.

For more call **0905 789 4179** (80p/min + network access charge)

Capricorn Dec 22 - Jan 20
 YOU aren't happy with the way a team effort is going. Too many people are in too much of a hurry and details are being ignored. Unless you are in charge, keep any critical feelings to yourself. Providing you're doing your work to the best of your ability, your conscience is clear.

For more call **0905 789 4180** (80p/min + network access charge)

Aquarius Jan 21 - Feb 19
 BOTH in work and social matters, it could pay off handsomely if you refuse to follow the crowd. Plenty of advice will be given but you should make important decisions independently. This may mean taking a risk and expressing those original and untried ideas that spring to mind.

For more call **0905 789 4181** (80p/min + network access charge)

Pisces Feb 20 - Mar 20
 YOU'VE always been sensitive and that's why it will hurt your feelings when a friend or workmate makes comments about you or your lifestyle. What upsets you most is that you felt comfortable with them enough you to reveal your vulnerabilities. Now you will wish you hadn't.

For more call **0905 789 4182** (80p/min + network access charge)

Letters..

Not so promising

HERE we go again with yet another broken promise by our dictatorial First Minister.

First she says we'll be allowed to do away with face coverings from March 21.

Then, because of a small hiccup in the figures, she promptly breaks that promise.

The silly thing is that if you go into a supermarket etc, more customers are not wearing masks than are.

This extension to wearing mask is just a joke and she is using it purely for her own ego.

She has run out ideas now IndyRef2 has sunk without trace. *David Grant, Banff, Aberdeenshire*

Letter of the week £50

Every Saturday we will pick the best letter received during the week and award a £50 prize. Please include your full name and address in order to be eligible.

★★★
 IT'S becoming clear that the more severe Covid restrictions in Scotland are a waste of time – we should have followed the UK Government's restrictions instead of trying to be different.

Not for the first time, we have a proportionally higher prevalence of Covid than England, which has had less severe restrictions for months.

What was the point – political, maybe? *Geoff, Stirling*

Is nothing sacred?

I AM annoyed at so-called celebrities showing off their baby bumps – who cares?

This is between husband



PROPOSALS Agricultural land could be rewilded or turn into solar farms

Solar farms won't feed us

IN THESE uncertain days, the UK must become self-sufficient in food production since it imports 48 per cent of the food consumed.

Why are the UK and Scottish governments allowing good agricultural land to be "rewilded" or turned into solar farms? Rewilding and solar farms will not

feed the nation. The UK and Scottish governments must for once agree and decree that local authorities refuse planning permission for solar farms and revoke any permission already given.

We are now on a war footing so farmland is vital for food production. *Clark Cross, Linlithgow*

and wife. Is nothing sacred nowadays?

Anne Lee, Troon, Ayrshire

Beam us OAPs up

WHAT a joke – MPs getting a pay rise of £2212 a year = £42.53 a week, now £84,144 a year.

We older pensioners on the

former basic state pension get yearly rise of £221 = £4.25 a week, now £7376.20 a year.

Gas and electric price rises are through the roof. Beam me up, Scotty. It's a madhouse down here.

Alan Taylor, Livingston

@dailyrecord

RECORD readers were keen to share their opinions after Nicola Sturgeon slammed the brakes on plans to lift face mask rules on Monday amid a spike in Covid cases.

The First Minister said the delay will be reviewed in two weeks, with the "expectation" that it will be converted into guidance in April.

Face coverings are required on public transport and in public places such as shops and gyms, as well when people are standing in pubs and restaurants.

The U-turn sparked anger among some.

June Thomson said: "It was obvious she wouldn't scrap it. She needs to hold on to what she can. Just get on, Covid isn't going

away – we need to get on with it."

Laurah Barr added: "Well, if the cases are going back up clearly the masks don't work anyway."

However, some readers saw it differently.

Carol King wrote: "Lots of people are saying, including retail staff, that they intend to still wear masks."

Your new bingo card is coming soon. Games will temporarily be shorter with more numbers each day.

PRIZE BINGO

Eyes down to play our brand new Prize Bingo card. **Game 53 has now ended.** Let's play Game 54 for £100. Today's numbers apply only to Game 54. When you have crossed off all 15 numbers for Game 54, claim for a full house.

HOW TO CLAIM:
Call our new number, **01420 525573** on Mondays between 10am and 3pm to claim. The prize for a full house is **£100**, split if there are multiple winners. Game rules available on request.



U-TURN Nicola Sturgeon

Get in touch

Write: Your View, Daily Record, One Central Quay, Glasgow G3 8DA Fax: 0141 309 3850 Email: letters@dailyrecord.co.uk

Social media

facebook.com/TheScottishDailyRecord twitter.com/Daily_Record

Pray

"HUMBLE yourselves therefore under the mighty hand of God, that He may exalt you in due time."

1st Peter 5:6

WE SHALL thank God that we were brought to our knees.

TEXT 'SISTERS' + YOUR QUESTION TO 61011
 Texts cost £1/reply. Max 3 replies. 18+. Entertainment only. SP: Allstar Psychics

The Spirit Sisters

..... Call or text our team of Psychics

BY PHONE BILL 0903 668 1031 **CALL & PAY BY CARD 0330 880 1031**

Calls cost £1.50/min plus network access charge. 18+ Entertainment only. SP Allstar Psychics. Calls charged at standard network price. 20 mins - £29.99 | 30 mins £39.99

THE Spirit Sisters | All calls recorded. 18+. Entertainment only. We cannot answer questions in regards to health, pregnancy, legal or financial related matters. You may receive free marketing messages. To opt out, STOPALL to 61011. Helpdesk - info@allstarpsychics.co.uk. SP: Allstar Psychics.

BINGO GAME 54
59 78 24 19 43 12 52 85 15 44 51 21 68 34 73

puzzles & cartoons.

COFFEE BREAK CORNER

NINER

Each number from 1 to 9 represents a different letter. Solve the clues and insert the letters in the appropriate squares to discover a word which uses all nine letters.

67759 gives an English city
1276973 gives a London district
3897436 gives a London football club

1	2	3	4	5	6	7	8	9
---	---	---	---	---	---	---	---	---

SUMMIT UP

If the number in each triangle is the sum of the two below, what is the top number?

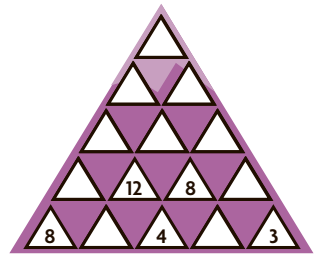

WORD SQUARE

A	A	C
T	I	G
T	N	K

Using the central letter and at least three others, how many words can you find? Plurals, proper nouns and hyphenated words are not allowed, and there is at least one nine-letter word.

Target:
25 - good;
35 - very good;
40 or more - excellent

EVENS

Insert any digit from 1 to 9 in the squares so that the numbers in each row and column add up to the given totals. No digits may be repeated within a row or column, and only even numbers may be placed in grey squares.

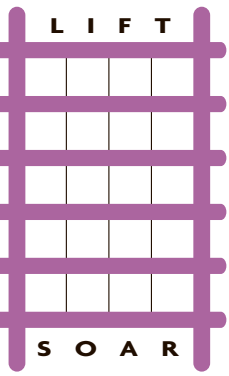

				11
				15
				30
				25
13	15	29	24	

WEE THINKER

Across

- 1 Material if crab is used (6)
- 5 See advertisement (6)
- 8 Warn that rate then was different (8)
- 9 Negative repeated, reversing time (4)
- 10 It's a spilt drink (4)
- 11 Features about recitals (8)
- 12 Bugles' unusual swellings (6)
- 14 I would appear in battle for 24 hours (6)
- 16 Supplement aided ITV broadcast (8)
- 19 Old application for waterway (4)
- 21 Hence in other goal (4)
- 22 Row to turn game round (8)
- 23 Lots in trouble often have it removed (6)
- 24 Listen out for trimming (6)

Down

- 2 Years to change each school (5)
- 3 About to get English monarch humming (7)
- 4 Copper and salt used on small weapon (7)

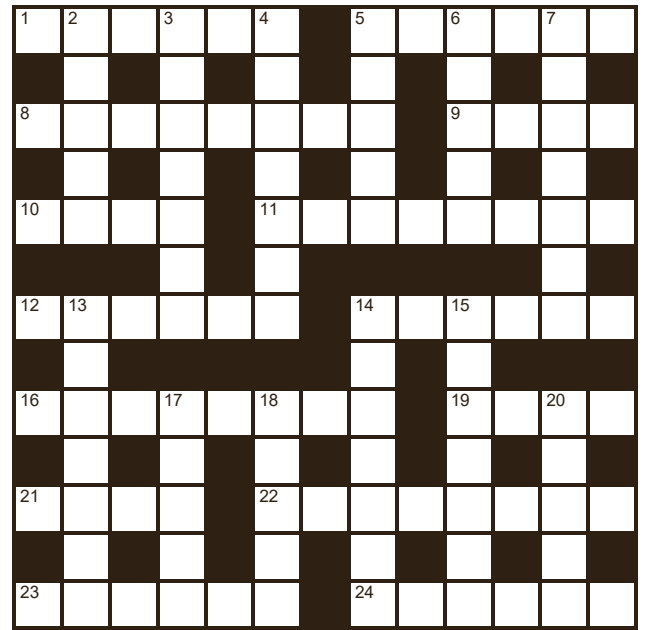

- 5 Band transported tonne (5)
- 6 Top may cut in terribly (5)
- 7 Church has a role treating disease (7)
- 13 Urged on to change experience (7)
- 14 Struggle to get engineers in transport (7)
- 15 Hero might be a bit rusty? (4,3)
- 17 Breaking up solid images (5)
- 18 At home with everyone, taken together (2,3)
- 20 Because church follows transgression (5)

ANSWERS

NINER CHANDLERS SUMMIT UP 83 WORD SQUARE ATTACKING EVENS 1253, 2175, 6789, 4597
 WORD LADDER One possible solution is: LIFT, LOFT, LOOT, BOAT, BOAR, SOAR

SUDOKU

EASY

7		5					3	1
	1		7	2	3	6		
4			5		2			
			3			8	7	
1		7	9	6	2	5		
	3	2						9
		1	3			9	6	
		9	2	4		3		
3	4			1				8

MEDIUM

	6	9		7		1		
	3			5		8	9	
2					8			7
	7			3				9
		6	7		9	5	8	
5			8				3	
6			4					2
	8	5		6		4	1	
		3		1				

ANSWERS

8	2	7	1	1	6	6	9	4	3
5	1	8	9	7	2	6	2	8	8
9	6	7	4	2	8	1	5	2	2
6	9	1	8	7	7	2	8	5	5
8	7	5	2	9	6	2	8	1	1
2	2	8	5	1	8	7	6	9	9
2	2	8	6	5	1	8	9	7	4
1	8	5	6	2	2	7	9	4	8
6	7	4	9	8	9	8	7	1	1
7	9	8	8	6	1	4	5	2	2
7	6	8	8	2	2	5	9	1	8
5	1	2	5	8	6	9	6	9	8

EASY

8	7	9	1	6	3	2	4	4
8	1	4	7	9	2	5	8	6
2	9	6	8	7	7	1	9	9
9	8	7	1	4	8	2	6	5
1	8	5	6	2	2	7	9	4
6	7	4	9	8	9	8	7	1
7	9	8	8	6	1	4	5	2
7	6	8	8	2	2	5	9	1
5	1	2	5	8	6	9	6	8

MEDIUM

QUICKIE

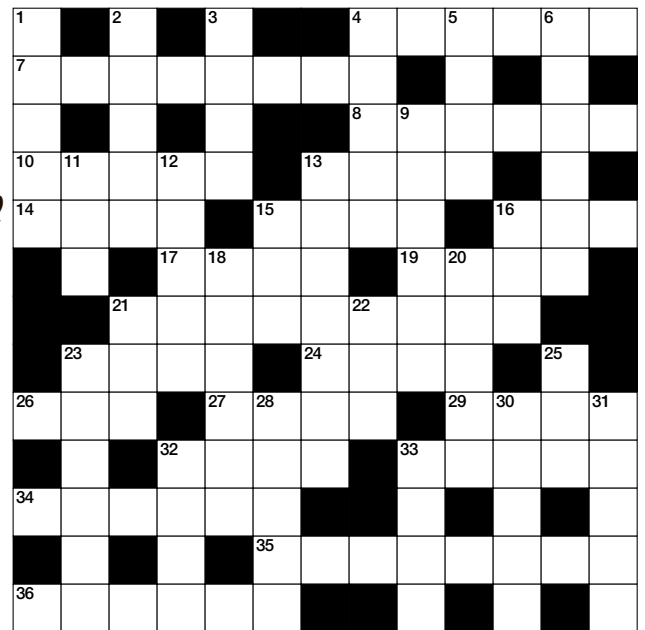

Across

- 4 Great fear (6)
- 7 Snake type (8)
- 8 Whips (6)
- 10 Quickly (5)
- 13 Short-term worker (4)
- 14 Grain store (4)
- 15 Merge (4)
- 16 Engage in pugilism (3)
- 17 Destroy (4)
- 19 Midday (4)
- 21 Modern, newfangled (6-3)
- 23 Card game (4)
- 24 Ado (4)
- 26 Laboratory, informally (3)
- 27 Stopper for a sink (4)
- 29 Religious image (4)
- 32 Watch face (4)
- 33 Employment (5)
- 34 Jewelled headdresses (6)
- 35 A cosmetic (8)
- 36 Condiment type (6)
- 13 Melodious (7)
- 15 Seizure (3)
- 16 Young male (3)
- 18 Perfect society (6)
- 20 Fertile spot (5)
- 21 Throw in a high arc (3)
- 22 Floor covering (3)
- 23 Salty (6)
- 25 Unhewn piece of timber (3)
- 28 Intense beam of light (5)
- 30 Shrewd (5)
- 31 Approaches (5)
- 32 Intravenous feed (4)
- 33 Unsightly (4)

Down

- 1 Spanish snacks (5)
- 2 Leading to death (5)
- 3 Painful (4)
- 4 Stories (5)
- 5 Course file (4)
- 6 American state (6)
- 9 Improves (6)
- 11 Baked pastry dish (3)
- 12 Yellowish-pink colour (5)

CARTOONS



YESTERDAY'S SOLUTIONS

WEE THINKER ACROSS: 5 Leads, 8 Soap opera, 9 Icicles, 10 India, 11 Ewers, 13 Amazon, 16 Status, 18 E-mail, 20 Adieu, 22 Rissole, 24 Appalling, 25 Rises.

DOWN: 1 Aspired, 2 Manifest, 3 Pool, 4 Persia, 5 Laminare, 6 Awed, 7 Sprat, 12 Satsumas, 14 Oratorio, 15 Allergy, 17 Script, 19 Paler, 21 Irks, 23 Salt.

QUICKIE ACROSS: 1 Bleats; 7 Kawasaki; 8 Topi; 10 Chorus; 11 Canine; 14 Ian; 16 Miser; 17 Talk; 19 Hotel; 21 Petal; 22 Minor; 23 Mess; 26 Havoc; 28 Tact; 29 Idiots; 30 Banana; 31 Exam; 32 Enlarges; 33 Trench.

DOWN: 1 Bobcat; 2 Anorak; 3 Skis; 4 Caramel; 5 Basis; 6 Viper; 8 Toil; 9 Pun; 12 Nil; 13 Needs; 15 Motor; 18 Ahead; 19 Hen; 20 Tar; 21 Picture; 22 Moo; 23 Manage; 24 Edam; 25 Search; 26 Hides; 27 Villa; 28 Tax; 30 Best.

DELIVERED TO YOUR SOFA, KITCHEN TABLE OR BEDROOM EVERY MORNING

The easy way to get your paper.. without leaving the house



THE TABLET EDITION

Have a digital version of the Daily Record and Sunday Mail effortlessly sent to your tablet or iPad every morning

READ IT JUST LIKE THE PAPER

FREE 60-DAY TRIAL
£9.99 AFTER

STEP 1

Open up the App Store on an iPad, Google Play on an Android tablets or Amazon Fire app store. You can only download the tablet edition on a tablet such as an iPad, Android tablet or Kindle Fire.



STEP 2

Click on Download or Install (it's best to be connected to wi-fi where possible for this, rather than 4G).



STEP 3

The app will download to your tablet, open it up and you will begin your free trial.



STEP 4

The app will automatically download the newspaper to your tablet each night. You can flick through the pages just like the print version... and you can even play the puzzles.



You'll find a frequently asked questions page at www.dailyrecord.co.uk/e-edition

city desk.

Booming bank to axe 69 branches

400 HSBC STAFF VICTIMS OF DIGITAL SWITCH

HSBC has confirmed plans to shut another 69 banks - meaning some customers will face more than a two hour drive to their next nearest branch.

Around 400 staff will be hit, although the banking giant insists they will be offered alternative jobs.

HSBC, which last month said profits doubled to £13.9billion in 2021, blamed the decision on more people doing transactions online.

It claimed the closures meant customers had an average distance of only four miles to reach another branch.

But that masks big variations.

For example, after the branch in Inverness closes on September 27, the next nearest is in Aberdeen - a two-and-a-half-hour drive away.

Critics say a wave of bank branch closures has particularly hit those who can't drive and rely on public transport. HSBC's latest cull begins on July 19, with three branches in London. Among the

others earmarked to go are Perth, Harborne in Birmingham, Hartlepool, Cardiff, Daventry, Ellesmere Port, Leyland, Dewsbury, Pontefract, Bishop Auckland, Ashby-de-la-Zouch, Ilkeston, Strood, Herne Bay, and Whitehaven, finishing with Falmouth and Bootle in October.

HSBC said it will provide alternative access through the Post Office, pop-up branches and via tablets supplied by the bank.

Jackie Uhi, head of HSBC UK's branch network, said: "The way people bank is changing - something the pandemic has accelerated."

"Our branches continue to support people with their more complex banking needs but the way we can do this has also evolved."

Jenny Ross, Which? Money Editor, said: "While many consumers now choose to bank digitally, millions of people are not yet ready or able to take that step."



CLOSURES
Banks go from July

» THE number of firms going bust has more than doubled in the past year. There were a total of 1515 registered company insolvencies in England and Wales in February. The figure compared with 685 the same month a year ago and was 13 per cent higher than in 2020, before the Covid crisis struck, according to data from the Insolvency Service.

OIL SLIDES DOWN

OIL prices dipped below \$100 a barrel yesterday as ceasefire talks between Russia and Ukraine eased fears of further supply disruptions and surging Covid-19 cases in China fuelled concerns about slower demand. The price of Brent crude dropped to a three-week low of \$98 a barrel at one stage during trading.

H&M Covid comeback

FASHION giant H&M says sales have accelerated over the past three months, as it bounces back from the impact of the Covid pandemic. Takings increased by 23 per cent to £3.9billion over the quarter to the end of February. Meanwhile, electricals chain Currys announced a 5.2 per cent increase to the minimum pay rate of its hourly paid colleagues, to £10 and £11.05 in London. It will take effect from August 1 and is the second rise in the past 12 months.



FTSE 100

down 17.7 at 7,175.7

Oil = \$102.1

Abrdn.....	196.3	-1.2	Imperial Brands.....	1558.0	+7.5	Smiths WH.....	1428.5	-1.0
Anglo American.....	3674.5	-24.0	International Airlines Grp.....	138.4	+1.4	Stagecoach.....	104.5	0.0
AB Foods.....	1724.0	-42.5	ITV.....	84.7	+1.2	Standard Chartered.....	471.5	-19.6
Admiral Group.....	2576.0	-7.0	JD Sports.....	141.8	-2.7	Taylor Wimpey.....	136.5	-3.2
AstraZeneca.....	9383.0	-13.0	Kingfisher.....	277.8	-6.2	Tesco.....	278.5	+1.5
Aviva PLC.....	414.2	-3.7	Land Securities.....	750.4	-10.8	Unilever.....	3381.5	-41.5
BAE Systems.....	732.4	+8.8	Legal & General.....	261.0	-4.0	United Utilities.....	1083.5	+22.0
B&M European.....	555.4	-3.2	Lloyds.....	47.4	-0.3	Vodafone.....	122.1	+0.3
BAT.....	3086.5	+61.0	Marks & Spencer.....	162.0	-3.5	Whitbread.....	2678.0	+30.0
Balfour Beatty.....	258.6	-3.2	National Grid.....	1155.4	+32.2	Reach PLC	184.0	-5.6
Barclays.....	168.2	-1.8	NatWest Group.....	215.3	-2.5			
BR Land Co.....	502.8	-4.0	Next.....	6240.0	-42.0			
BP.....	361.0	+4.5	Ocado.....	1188.0	-6.0			
BT.....	178.0	+2.8	Pearson.....	826.8	+65.8			
Capita Group.....	21.0	-0.3	Persimmon.....	2228.0	-64.0			
Carnival.....	1261.8	+30.6	Prudential.....	1000.0	-44.0			
Centrica.....	78.4	+1.5	Reckitt.....	5797.0	+101.0			
Compass.....	1655.5	+1.0	RELX.....	2189.0	+56.0			
Currys Plc.....	84.9	-7.5	Rentokil Initial.....	485.5	-1.3			
Diageo.....	3455.5	+2.0	Rio Tinto.....	5210.0	-89.0			
Direct Line.....	269.9	-4.2	Rolls-Royce.....	92.3	-1.5			
Easyjet.....	522.8	+16.6	Royal Mail.....	363.5	+3.7			
Ferguson.....	10950.0	-720.0	J Sainsbury.....	258.4	+0.8			
Frasers Group.....	626.0	-8.5	SSE.....	1677.0	+19.5			
GlaxoSmithKline.....	1570.0	+9.4	Seymour Powell.....	2918.0	+60.0			
Halfords.....	254.0	-4.8	Serco.....	133.3	-1.1			
Hays.....	124.9	-1.1	Shell Plc.....	1940.0	+13.2			
HSBC.....	479.7	-9.9	Smith & Nephew.....	1205.0	-7.0			

Holiday £

Euro.....	1.160
Australian Dollar.....	1.759
Bulgarian Lev.....	2.207
Canadian Dollar.....	1.624
Croatian Kuna.....	8.585
Egyptian Pound.....	16.612
New Zealand Dollar.....	1.859
Polish Zloty.....	5.330
South African Rand.....	18.928
Swiss Franc.....	1.186
Thai Baht.....	41.686
Turkish Lira.....	17.593
UAE Dirham.....	4.622
US Dollar.....	1.280

saltire STAIRLIFTS



GLASGOW
AYRSHIRE

0141 471 7270
01292 281070
FREEPHONE

ABERDEEN
EDINBURGH
0800 111 4217

01224 453 076
0131 603 0708



WE ARE AN
AWARD WINNING
STAIRLIFT COMPANY
WHO OFFER
FREE SURVEY, DELIVERY
AND INSTALLATION
THROUGHOUT
SCOTLAND

- > FREE 1ST YEARS SERVICE
- > LOCAL SERVICE
- > INDOOR & OUTDOOR STAIRLIFTS
- > STRAIGHT OR CURVED
- > NEW OR RECONDITIONED
- > RAPID INSTALLATION



STAY IN YOUR
OWN HOME WITH
A STAIRLIFT
FROM SALTIRE
HEALTHCARE-
the family business
that cares.



GUARANTEED
BUY BACK ON
STAIRLIFTS
PURCHASED
FROM US

FINANCE NOW AVAILABLE

Which?
Trusted trader

www.saltirehealthcare.co.uk



KITCHENS & BATHROOMS

£2995

Supplied and fitted

RANGES TO SUIT ALL BUDGETS



KITCHENS

BATHROOMS



Call: **0141 889 3221** | www.instyle.scot

FREE Oven, Hob and Extractor Fan or Electric Shower, Luxury screen & tiling, **LIMITED STOCK!**

ALL SAFETY PRECAUTIONS TAKEN FOR COVID-19

SHOWROOM OPEN 6 DAYS A WEEK
MONDAY - SATURDAY 10am - 5pm



instyle
kitchens & bathrooms

OUR SHOWROOM:
1B Greenock Road, Paisley, PA3 2LB



A BETTER ALTERNATIVE TO
ROUGHCASTING & PAINTING



After

WITH THOUSANDS OF PROTECTED PROPERTIES THROUGHOUT THE UK, 45 YEARS DECADES OF EXCELLENCE

The Proteks System has proven itself time and again. Whether it's painted, roughcast, pebble dashed, rendered, natural brick or stone - The Proteks System can transform any property, adding value and long life good looks and protection.



Before

- ✓ Protect and waterproof your walls
- ✓ Damp proofing solutions
- ✓ Long lasting solutions
- ✓ Unique anti-fungicide treatment
- ✓ Add value to your property
- ✓ Maintenance free 25 years or more
- ✓ Over 100 finishes available
- ✓ All work fully guaranteed

EXTERIOR WALL, DRIVEWAY & ROOFING PROBLEMS SOLVED!



OFFER CODE **RD11**

Call for a free no obligation survey & quotation
0800 058 2564 | www.proteks.co.uk

Alarms & CCTV

Your Home Made Safe Today!

INTRUDER ALARMS	CCTV SYSTEMS
FULLY INSURED	VIEW ON YOUR MOBILE
FREE ESTIMATES	FULLY RECORDABLE

Call Your Local Trusted Tradesman
Fast - Low Cost - Local
0141 648 7969 | 07868 809 400

Titus alarm & CCTV

Your TV Reception Fixed Today!

Bad Reception?
No Signal?
Picture Freezing?

Friendly local fully insured engineers
in your area today - Call now!

Aerial & Satellite Specialists

Free Estimates - TV Wall Hanging

0141 648 7968
07868 809 796

Scottish Aerial & Satellite Services



DAILY RECORD
HOME IMPROVEMENTS



Call
0141 309 4940

for information
on how to
advertise

GOLF

RYDER CUP SKIPPER'S VOW

JOKER IN THE PACK

ACE IN ATTACK

PLAYING IT FOR LAUGHS
Stenson will lead Europe into battle and, below, famous green wig from 2006 victory

K Club wig antics won't stop because I'm the captain, insists Henrik, as fightback begins



HENRIK STENSON has promised to bring a splash of colour to Europe after being charged with the task of winning back the Ryder Cup in Rome next year.

The 45-year-old Swede, who has signed a loyalty pact after flirting with the breakaway Saudi rebel tour, was yesterday unveiled as Europe's captain for the contest against USA at Marco Simone Golf Club in 18 months' time.

Stenson says his quirky sense of humour will be part of the package. He said: "They're going to get Henrik. I don't see myself changing too much.

"In terms of the humour side of things, that's just in my nature. I've been able to bring it to the Ryder Cup in the past - I don't know if the green wig at the K Club is evidence enough - but I'm never

BY NEIL SQUIRES

too far away from some laughter. We want to get a good atmosphere."

At last year's Open, Stenson placed tuna on toast on top of the campervan Ian Poulter was staying in, with the result his former Ryder Cup team-mate was woken at 4am by what he described as sounding like a stampede with a flock of grateful seagulls pecking at the metal roof.

Stenson will be a contrast to America's strait-laced captain Zach Johnson, who was appointed a fortnight ago.

Lee Westwood had been favourite to succeed Padraig Harrington as

captain but pulled out of the running in November to try to make it to Rome as a player and break Nick Faldo's appearance record from 11 Ryder Cups.

Luke Donald also had his backers but he lost out to Stenson after the interview process last week.

It is a tough challenge to take on after Europe were thrashed 19-9 by the Americans at Whistling Straits last September but they have a proud home record of having not lost on their own soil since 1993.

And Stenson **STRAIT-LACED US** skipper Zach Johnson

added: "The American side played a lot better golf than we did.

"We simply got outplayed by a better team.

"But we have done a big debrief which will help us.

"I'm going to get the strongest team possible assembled and we'll come back stronger at Marco Simone in 2023."

Stenson - who was an assistant captain last time around - has played in five Ryder Cups, securing the winning point with a singles victory over Vaughn Taylor on his debut at the K Club in 2006.

He then formed a formidable partnership with Justin Rose, ending unbeaten at Le Golf National in 2018 in his three matches there.

In all, the 2016 Open champion has won 11 points for Europe in 19 matches.



RELISHING THE CHALLENGE Hamilton

Hamilton: I'm back to fight for eighth title

FORMULA 1

BY SIMON CASS

LEWIS HAMILTON wants to banish the memory of his Abu Dhabi heartbreak by landing a "mind-blowing" eighth world championship this season.

The pursuit of that record-breaking aim begins in Bahrain on Sunday as the new campaign roars off.

And with a fresh set of radical regulations, Hamilton is relishing the challenge of once again trying to surpass Michael Schumacher's record title haul - and taking the fight to the reigning world champion Max Verstappen.

Ahead of his 16th campaign on the grid, Hamilton said: "It would mean everything to win an eighth title.

"It's impossible to know what the future holds and what it would feel like but doing something that no one else has done would be mind-blowing."

Hamilton, 37, toyed with retirement after Red Bull's Verstappen took advantage of a late safety car - and a contested referee's call by the now axed Michael Masi - to beat his British rival to the title at the season finale in Abu Dhabi.

But now the Mercedes driver claims the bitter disappointment was a learning experience, as he seeks revenge for last year's debacle in the desert.

He said: "Abu Dhabi was a difficult period of time. I had to unplug, I really needed the time to re-centre, refocus.

"My whole life's been about winning. I've been racing for 29 years. But I've realised winning is not everything and sometimes when you lose, you win and grow.

"I've come back to fight for that eighth title. That's what I'm here for. I still love what I do. I didn't think at this age I'd still feel so sharp, so energised. I know exactly what I want - and I know how to get there."

Paterson eyes Vegas bounty

CURLING

ROSS PATERSON will return to Sin City to help spearhead Scotland's charge at the World Men's Curling Championships.

The national champions, Team Paterson, have been selected for the Las Vegas showpiece starting on April 2.

Kyle Waddell, Duncan Menzies and Craig Waddell complete the quartet, who beat Ross Whyte's outfit at last month's Scottish Championships in Dumfries.

Paterson, fifth man for Team Mouat's bronze in Vegas four years ago, is heading to his fourth World Champs while his team-mates prepare to make their debuts.

Stenson puts Saudi noise to one side for Europe

HENRIK STENSON insisted he was fully committed to the European Tour after being appointed Ryder Cup captain.

Reports in January had suggested the Swede had been given an ultimatum to choose between Europe and the big bucks from the breakaway Saudi Golf League.

But his presentation as

BY DALE RANKIN

Padraig Harrington's successor ended any speculation.

"There has been a lot of speculation back and forth," said the Florida-based golfer who is Sweden's first captain.

"Yes, the captain signs a contract. He's the only one who does. I am fully committed to the captaincy, Ryder Cup

Europe and the job at hand. We are going to keep busy with that and I'm going to do everything in my power to deliver a winning team in Rome."

There was a feeling that September's painful defeat in Wisconsin would signal the changing of the guard.

Stenson declared "the door is open for anyone with a

European passport" as he said: "Our average age at Whistling Straits was near enough 35 and the American side had about a 26-year average.

"At some point there will be a shift and I can definitely see that happening this time around. I can also see a few hungry veterans want to keep their jerseys.



PREDECESSOR Padraig

RUGBY SCOTLAND SIX NATIONS CRUNCH

MATT FAGERSON admits this Six Nations has been a big disappointment for Scotland.

But he reckons the form book will go out the window when they take on championship-chasing Ireland in Dublin on Saturday.

The campaign started brightly for the Scots when they pulled off an excellent home win over England but Gregor Townsend's team then slumped to back-to-back defeats against Wales and France.

Victory over Italy in Rome last weekend relieved some pressure but it was a patchy performance which left a lot of fans frustrated.

However, No.8 Fagerson believes the team is still moving in the

Fagerson isn't focusing on past, only present as he vows Dublin decider isn't a done deal

BY DAVID BARNES

right direction under Townsend, and he has backed Scotland to finish this Six Nations campaign on a high.

He said: "We are disappointed in the way we didn't back up our England performance against Wales

"And then France was really tough because we lost Hamish Watson to Covid the day before and there were a few other little things.

"But you can see that anyone can beat anyone.

"England beat Wales and

we had a narrow loss to Wales, and in years gone by France

have beaten teams and then we've gone and beaten France.

"So, we're not going to be reading too much into what has gone before going into this weekend.

"We're definitely growing as a team - our DNA is there and as a group we're quite cohesive at the minute.

"Barring results, some of the stuff we're putting on the pitch is really, really good.

"I know I can sound like a broken record sometimes with this Scotland team but in the last two years especially there have been massive shifts in our defence.

"And when things click, our attack is really good as well.

"It's about finding that

consistency. Things can go wrong in a game but if we can go back to our principles then it's an easy template to fall back on.

"We've definitely improved and hopefully we can show that again this weekend."

In order to win the championship, Ireland need to beat Scotland on Saturday afternoon and hope that England do them a favour by topping France later that night.

It is a long shot but it means there is no chance of Andy Farrell's side being short of motivation or focus at the Aviva Stadium.

Fagerson said: "They have a ruthless streak that you saw against Wales and even when they lost to France but took them to the wire. They've

definitely added a whole load of new strings to their bow in recent seasons, and Jamison Gibson-Park at scrum-half brings a bit of tempo to their game which is huge.

"They are trying to play a more expansive and high-tempo game of rugby, and if you give them the opportunity to do that then they can be really dangerous.

"Hopefully, our defence will be able to wrap them up and slow them down a bit.

"I probably don't want to dive too much into what their crowd are going to bring on an occasion like this.

"We knew it was going to be the final day and that it would probably hang in the balance.

"Obviously, we were hoping to be in a different position but it is what it is.

"If you look into the occasion more it'll take away from our roles. We need to focus on ourselves on the day."

ROOM TO ROME
Fagerson played his part in win over Italy



Form doesn't mean we're Six feet under

DEAN: WE'RE ON ATTACK TOO

EDINBURGH centre Chris Dean thinks Friday's 1872 Cup match against Glasgow at Scotstoun could be a classic - now that both teams are playing attacking rugby.

The Gunners used to have a limited game plan but Dean believes that taking a leaf out of the Warriors' playbook could pay dividends for his

side. And Dean said: "Glasgow are enjoyable to watch and play with a lot of flair and excitement.

"They've built up a really good fan base through that style of rugby we're now switching to.

"So hopefully we can follow suit and make our mark that way too, which should lead to a really exciting match."

Jamie: Friday will be the real deal

GLASGOW starlet Jamie Dobie played in two 1872 Cup games in front of empty stands last season.

But the 20-year-old scrum-half reckons the match on Friday against Edinburgh will feel like his real debut in the fixture - because it will be at a full Scotstoun. He said: "I got a

chance to play in a couple last season, but without the crowds.

"A packed-out Scotstoun is what everyone wants to be playing in front of. So to have that crowd behind us on Friday night - and there will be plenty of Edinburgh fans across as well - is good for both teams."

Adam aims to salute grandad with gold

ATHLETICS

ADAM THOMAS wants to bring a gold back from this week's world indoors to honour the grandad who put him on track for a sporting career.

The new Scottish 60 metres record holder will jet to Belgrade today after a breakthrough spring that's brought him a first British title and international vest.

The 26-year-old is born and bred in Reading but is a proud member of the Tartan Army with an Aberdonian mum whose late father James, he says, would have loved to see him sprint against the best in the world.

Thomas said: "He was a very big influence in mine and my brother's sporting life. He came to pretty much every single event that we had.

"When he passed away, it was shortly before the Glasgow Commonwealth Games. And I thought what better way to salute his impact on my life than to compete for Scotland?"

Thomas will eye up a



EXCITED Adam Thomas

final berth in Serbia before turning his attention to chasing spots at this summer's Commonwealth Games and European Championships.

A late bloomer, he has finally hit his stride after five years of climbing up the circuit. But the GB&NI international admits the turning point was quitting Loughborough and moving out of the British athletics bubble.

"It was really intense and I found myself not enjoying it," he said.

"So that came on to the track on race days. So I came back home and went back to the coach I was working with before. And it freed me up."

And it's earned him a shot at the likes of world 100m champion Christian Coleman in Belgrade this weekend.

"I'm super-excited to be able to run against the big guns," Thomas added. "But I'm hoping I can just keep doing what I've been doing."

Mark Woods

ENGLISH

LATEST DOWN SOUTH

Chelsea and sporting integrity do not belong in same sentence

Boro chief Gibson fires back after Blues bid for closed-doors clash

CHELSEA were forced into a humiliating climbdown after becoming embroiled in a bitter row over FA Cup tickets.

The Blues made a public request asking for Saturday's FA Cup fifth-round tie with Middlesbrough at the Riverside to be played behind closed doors in the interests of "sporting integrity".

That prompted a furious response from Middlesbrough and their chairman Steve Gibson as both launched an attack on Chelsea.

The Riverside club hit back with a strongly-worded statement that said: "Given the reasons for these sanctions, for Chelsea to seek to invoke sporting 'integrity' as reason for the game being played behind closed doors is ironic in the extreme."

And Gibson is quoted as saying: "Chelsea and sporting integrity do not belong in the same sentence."

It led to Chelsea withdrawing the

BY JOHN CROSS

request after "constructive talks" with the FA as they still hope to reach agreement with the government to relax rules over ticket sales.

The government were frustrated with Chelsea for going public while they were trying to find a solution as they stressed sanctions on Roman Abramovich were the priority as they take a stand against Russian oligarchs and Vladimir Putin.

It remains to be seen if they can reach agreement regarding ticket sales in time for Saturday but the government are open to reviewing the current licences.

Chelsea went public as they believe it would be unfair for them to have just 500 fans, who bought tickets before sanctions were introduced, compared to a sell-out Middlesbrough crowd at the Riverside. But the club's frustration

was more with the government over licences blocking fans going to games as they can't understand why Chelsea can bank money from TV revenue but not ticket sales.

The Blues will also ask the government to review their £20,000 limit on travel costs for away games arguing it would not even cover the cost of a hotel for Middlesbrough while they would have to make a 10-hour round trip by coach.

A government spokesperson said: "We are meeting on a daily basis with the club and football authorities to discuss further amendments to the licence designed to ensure Chelsea can continue to undertake football activity."

Meanwhile, UEFA insist Chelsea's Champions League tie in Lille will "as it stands go ahead" despite reports in France suggesting EU sanctions against Abramovich could put it in doubt.

WILLING TO CHIP IN
Havertz says Blues would pay own travel costs so preparation goes smoothly

Havertz: We'd pay our way on road

» **LILLE v CHELSEA**
8PM, BT SPORT

BY MATTHEW DUNN

KAI HAVERTZ claims Chelsea's stars would pay their own way to arrive at games properly prepared.

The squad flew to tonight's Champions League clash in Lille as all their travel arrangements had been booked before sanctions were brought against Blues owner Roman Abramovich.

But with a £20,000 cap on future away trips now in place, forward Havertz feels the players would chip in rather than cut corners to prepare.

The German said: "That's not a big deal for us. For us to come to the games is the most important thing."

"There are much harder things in the world at the moment than if we have to take the bus or plane to an away game. I would pay."

And as war continues to rage in Ukraine, he called for some perspective.

Havertz added: "There are bigger things happening than us playing football. "You see the images and think that it's not possible this can happen."



RETURN Christian Eriksen

Christian's back after Euro 2020 collapse

BY ALEX RICHARDS

CHRISTIAN ERIKSEN has been recalled to the Denmark squad for the first time since suffering a cardiac arrest at Euro 2020.

The midfielder, whose collapse occurred in the match against Finland in Copenhagen last June, has not played for his country since the incident, which saw him undergo life-saving surgery treatment.

But Eriksen was yesterday named in the 23-man squad for Denmark's friendlies against Holland and Serbia following his impressive return to action with Brentford in the Premier League.

Denmark boss Kasper Hjulmand said: "I expect Christian to go in and to be a deciding factor for our team. I did not expect him to play right now - I thought he would be ready by the summer."

"However, Christian is with the squad because he is the best in that position and is in good shape."

After being fitted with an implantable cardioverter defibrillator device, he was forced to leave Inter Milan in December, as Serie A rules would not allow him to continue playing in Italy.

The former Tottenham star joined the Bees in January and only made his debut for Thomas Frank's men on February 26, playing in the final 38 minutes of the 2-0 defeat to Newcastle.

He has since played the full 90 minutes in matches against Norwich and Burnley.

Eriksen, who has won 109 caps and scored 36 goals for his country, is desperate to secure a place in the Danish squad for the World Cup in Qatar later this year.

Hjulmand added: "I saw him against Burnley on Saturday where he was the best player out there."



CUP ROW Gibson, top, and Abramovich

Tuchel: PM should have other things on mind

THOMAS TUCHEL has rounded on Boris Johnson, suggesting the Prime Minister should have bigger concerns than Chelsea fans singing their support for Roman Abramovich.

The Blues manager had already condemned his own supporters for interrupting the tribute to Ukraine, at Burnley earlier this month, by calling

out the Russian oligarch's name. Then on Monday a spokesman for the Prime Minister blasted "inappropriate behaviour" of supporters backing their sanctioned owner.

When asked about it in the midst of preparing for Chelsea's Champions League trip to Lille tonight, Tuchel said: "I heard about it some minutes ago. I

really don't know if, in these times, it is the most important discussion to have in Parliament.

"I don't know if fan chants being discussed in Parliament means we have to worry about the priorities of this government.

"But OK, listen, no need to comment from me. We have far more urgent things to discuss and handle at this time." The

Court of Arbitration for Sport has upheld the decision to ban Russian teams from UEFA competitions.

The interim judgment means Spartak Moscow will no longer take part in the Europa League, although Russia's participation in the World Cup will be decided in a fuller meeting of the council.



FIRING BACK Thomas Tuchel

RYDER CUP & RUGBY

PAGES 38&39



DUNDEE

CRISIS AT DENS PARK

Fans voted with feet and Nelms' no-shows latest sign of shambles

IT WAS A CASUAL REMARK FROM A friend which struck a chord as he discussed the latest shambles at Dundee.

"It's a bit like Raith Rovers, Airdrie and Falkirk.....some clubs just attract s***"

Mmmm...maybe a bit unkind but fair point all the same – and hard to argue given decades of drama and trying to keep themselves afloat.

Living in Tayside as a teenager was an introduction into a bygone age, a City of Discovery where the dark blue team on Sandeman Street was stuck in the past.

Three decades later and nothing has changed.

As is usually the case when supporters air their grievances, it's the small things about the ground which grate.

No chip and pin at the cash-only snack bar kiosks, and a tannoy system of such muffled proportions it sounds as though the announcer's been abducted by the scary voice guy from Saw.

Toilets from a scene from Train-spotting, and a stadium of such disrepair it appears all attempts at any sort of improvements have been taken off the table.

The Never, Never Land site of a brand new stadium at Camperdown remains untouched and that's only a tale of woes which doesn't touch what's happening on the park.

The decision to put a £30 premium on tickets for the Rangers match was a move which highlighted someone who is so out of tune with his own support. Who can blame the thousands of Dundee fans who



NO-SHOW
Thousands of Dundee fans stayed away from Sunday's Cup match

Absence makes the heart grow sombre

» SPORTS VIEW WEDNESDAY

Gordon Parks



decided against shelling out and opted against turning up?

Here's another honest list of what this observer sees from the outside and half an ear on a few people within the club who actually appear to care.

An absentee owner and a managing director in John Nelms who opted for an oval ball at the weekend by attending Scotland's game against

Italy in Rome rather than his own Scottish Cup tie against Rangers at Dens the following day.

Not just a poor show, it stinks.

Nelms was neither at the St Mirren game in midweek nor in attendance when it matters most and as a decision-maker he's gone from bad to worse.

When James McPake led Dundee

back into the Premiership last summer, this reporter asked Nelms about his young manager and what followed was a soliloquy of sorts about a guy who's family, a son and someone who's going to continue in the post with more backing than before.

Not that much of a son it was to prove, cue the basket-case move to remove a bright young boss and the only thing prodigal was to allow Gordon Strachan to appoint his pal Mark McGhee in his

MISSING John Nelms

place. It gets worse. Whisper it but it appears assistant boss Simon Rusk is actually the de facto man in charge.

All this is adding up to a relegation campaign. It's also not an assault on a club but a statement of facts with which the fans themselves are in tandem.

Football and poor stewardship are under the microscope more than ever and it's blaring through the Dundee tannoy that big problems are afoot.

They can muffle it all they want but some clubs do attract "s***".



GET OUR BEST EVER ACCA

- ✓ **Boost**
- ✓ **Edit**
- ✓ **Track**
- ✓ **Insure**

Ladbrokes

COOL CALLUM KILLS FULHAM

RESULTS & ROUND-UP

CALLUM ROBINSON'S neat second-half finish helped West Brom inflict runaway Championship leaders Fulham's first league away defeat since October in a 1-0 victory at the Hawthorns.



ON TARGET Robinson

Fulham failed to register a single shot in the first half in an under-par display from the usually free-scoring side.

Tom Ince scored a late leveller to boost Reading's survival hopes and dent Bournemouth's push for automatic promotion in a 1-1 draw.

Fourth-placed Blackburn came from behind to beat Derby 3-1.

CHAMPIONS LEAGUE

ROUND OF 16 SECOND LEGS

AJAX.....0 BENFICA.....1
(agg: 2-3)
HT: 0-0
Nunez 77

MAN UTD.....0 A MADRID.....1
(agg: 1-2)
HT: 0-1
Lodi dos Santos 41

SCOTTISH LEAGUE TWO

COWDENB'TH...1 FORFAR.....2
Mullen 36 Thomson 13
HT: 1-1
Munro 84

	P	W	D	L	F	A	P	T
Kelty	28	21	4	3	59	24	67	
Annan	29	16	5	8	53	35	53	
Forfar	29	14	8	7	48	31	50	
Edinburgh C	29	12	8	9	37	38	44	
Stenny	29	11	8	10	39	39	41	
Stranraer	29	9	8	12	38	46	35	

Andy's handy as Forfar dump the Blue Brazil

ANDY MUNRO headed in the winner six minutes from time as Forfar edged out Cowdenbeath.

**» COWDEN.....1
» FORFAR.....2**

The result sees the Loons extend their lead in third spot to six points while the Blue Brazil remain seven points adrift at the foot of the League Two table.

Forfar went ahead in 13 minutes as Craig Thomson sent a shot squirming under the keeper. But the

leveller came in 36 minutes when Fraser Mullen slotted home Quinn Coulson's ball to the back stick.

The second half was evenly matched but with six minutes to play Munro broke free and powered a header towards goal.

Despite being cleared off the line, the ref gave it.

McDonald: We must be wary of battling Albion

KEVIN McDONALD insists Kelty Hearts must up their game when facing Albion Rovers tonight for the second time in five days.

The League Two leaders maintained their 14-point advantage on Saturday with a 3-1 home win.

But Kelty's No.2 said: "They'll take encouragement from their second-half performance. Brian Reid will have been delighted

**» ALBION ROV v KELTY HEARTS
TONIGHT, 7.45PM**

with his players and will bring that into Wednesday, so we must be better."

Cliftonhill gaffer Reid said: "We have got to take confidence from Saturday.

"Kelty are strolling away with the league and have quality players. But we were the better team second half"



CHAMPIONS LEAGUE

NO QUARTER GIVEN Atletico boss Simeone wheels off to celebrate at Old Trafford



SO the trophy drought goes on for Manchester United.

At this rate Manchester City fans will put up a banner at the Etihad marking the number of years since their local rivals last lifted silverware.

United had such a banner at the Stretford End for 35 years mocking City's lack of success.

But now it is their turn to suffer such indignity.

You have to go back to the Europa League win of 2017 for the last time United lifted a trophy.

In truth, even had United progressed to the last eight, there was little chance of them going all the way and being crowned champions of Europe given their glaring limitations.

Those shortcomings ultimately led to their meek exit here, United lacking the quality and tactical nous to find a way past the well-drilled Spanish champions who fully deserved to go through.

As soon as Diego Simeone's streetwise side took the lead just before the end of the first half, it was always going to be an uphill task for the home side to find a way back into the tie.

Twice finalists under Simeone, Atletico's game management was far superior to United's as they exposed the limitations of interim boss Ralf Rangnick's side and the scale of the job facing the new permanent manager this summer.

United keeper David de Gea said: "We did not do enough in both games to win it. It's a very disappointing day for us.

"They are a team with a lot of experience. They know how to play those Champions League games. They scored a goal then are a tough team, so it was hard for us to create chances.

"As soon as they scored the goal they put the whole team in front of Jan Oblak. They are a very defensive team and it's difficult to score against them. We tried until the end but it was not enough."

"We are out of one of the most important competitions so we are very sad. Of course it's not good enough. It's hard for the club, for us and the fans. This is where we are at the moment. It's a difficult situation.

"We have to keep fighting. But we were not good enough." Yet

» MAN UTD....0 ATLETICO MADRID....1

DAVID MCCONNELL AT OLD TRAFFORD AGG 1-2

United began the game brightly and went close to taking the lead in the 12th minute, a fluid move involving Diogo Dalot, Cristiano Ronaldo and Bruno Fernandes ending with Anthony Elanga's shot from point-blank range blocked by the face of Atletico keeper Oblak.

Three minutes later and it was the turn of the away side to go

close, Rodrigo de Paul unleashing a goalbound shot from 25 yards that was kept out by an equally majestic save at full stretch from de Gea.

Atletico had the ball in the United net just after the half-hour mark after a superb move involving skipper Koke and Marcos Llorente, whose cross was turned in by Joao Felix. But

the goal was correctly ruled out for offside against Spanish wing-back Llorente.

The away side went ahead four minutes before the break, the goal coming against a back-drop of controversy with United furious they had not been awarded a foul at the other end for a challenge on Elanga.

Referee Slavko Vincic had his whistle to his mouth and seemed ready to blow for a foul but waved play on. Atletico cashed in, Antoine Griezmann crossing for

Nod from Nunez dashes Dutch hopes

DARWIN NUNEZ'S 77th-minute winner means Benfica are heading to the quarter-finals.

The Uruguayan striker rose above the Ajax defence to nod in from a free-kick in a rare attack to stun the hosts in Amsterdam.

Benfica's veteran centre-back pair of Jan Vertonghen and Nicolas Otamendi were a solid wall Ajax

**» AJAX.....0
» BENFICA.....1**
AGG 2-3

were unable to break down, despite dominating possession.

And with just 13 minutes to go, Edson Alvarez brought down Goncalo Ramos on the right-hand side. Alex Grimaldo's perfect

delivery of the resulting free-kick let Nunez get a jump on Jurrien Timber, leaping to reach the ball before Andre Onana and head home.

Ajax - who had been expected to ease into the last eight - could have levelled in stoppage time but Benfica keeper Odysseas Vlachodimos pulled off a superb stop to deny Brian Brobbey, who was then ruled offside.



UP FOR WINNER Nunez joy

LAST-16 ACTION



OVER AND OUT De Gea comes up for a late corner, far left, after Lodi revels in his goal



CASH STAND-OFF But Salah won't be distracted says boss

MO ROW WON'T KO TITLE PUSH

» ARSENAL v LIVERPOOL

TONIGHT, 8.15PM

BY CHRIS MCKENNA

JURGEN KLOPP insists Mo Salah's contract stand-off won't derail Liverpool's Premier League title bid.

The Anfield frontman has yet to agree a new deal with his current one set to expire next year.

The club and the player are at loggerheads over his wage demands.

Last week, Klopp spoke about how the club have done all they can in talks and it's now down to Salah.

That prompted the player's agent, Ramy Abbas Issa, to post laughing emojis on Twitter.

But the Liverpool boss has no fears Salah's focus on pushing the Reds towards the title will be disrupted by the noise.

The German said: "I don't have to remind any player and for sure not Mo of that. No chance."

The Reds have 10 games to go, starting tonight against Arsenal away at the Emirates.

After Manchester City's goalless draw with Crystal Palace on Monday night, they can narrow the gap at the top to just one point.

And with a clash with the defending champions to come on April 10 at the

Ethad, it means Liverpool would be crowned champs if they pulled off the unthinkable and won every remaining game.

Klopp said: "We try to win all the games. It is really difficult but we will see. It is in our hands."

Mikel Arteta says Arsenal are still far from where he wants them to be despite enjoying the best spell of his two-and-a-half year reign.

The Gunners sit fourth, a point clear of Manchester United having played three fewer games.

Asked how far away the club are from reaching the targets he set when taking over in December 2019, Arteta said: "Still far. We are much closer than we were and probably the closest we have been in terms of what we are looking for."

"But I focus on that gap and that gap is still big."

"We have to make things quicker, sharper. We can be more adaptable, we can be much more unpredictable and we can have much more flexibility."

Reds can show they are perfect 10 at Emirates

LIVERPOOL stand just 10 wins from another league crown but face a huge test of their title credentials at Arsenal tonight.

Manchester City's slip at Palace on Monday means the Reds can overtake them at the top if they have a perfect run-in.

They have won their last eight in the league but now face a Gunners side who have reeled off five successive wins to move up to fourth. The Reds

Mr Fixit

won 2-0 on their last visit and that's why they're odds-on at 66/67 with SBK.

Chelsea visit Lille in the Champions League with a 2-0 lead and McBookie make them 1/66 to reach the quarters.

Super singles

Chelsea win on night (13/14, SBK).

Alvaro Morata to score for Juve against Villarreal (19/10, McBookie).

BET BUILDER

COMBINING BTTS no at Anfield with over 6.5 corners pays 122/100.



McBookie offers anytime card and scorer markets for all SPFL Bet Builders. Check out the site today.

UNITED FLOORED BY ATLETIKO

Drought goes on as Simeone's Spaniards storm Manchester

Renan Lodi, who wrongfooted de Gea with his far-post header.

On the referee, de Gea added: "I do not want to speak about the referee. Everyone watching can see and we cannot change it."

United's players surrounded the ref for his failure to blow for a foul on Elanga but the brutal truth is the 19-year-old needed to be stronger when challenged rather than going to ground and hoping for the decision to go his way.

Shoddy defending at the other end compounded United's

misery. Elanga nearly levelled within 30 seconds of the restart, scampering on to a clever flick from Fernandes, but dragged his shot just wide of Oblak's far post.

Jadon Sancho blazed a volley over the bar just before the hour as Atletico withstood everything United threw their way.

Simeone's side went through their full repertoire of dark arts - time wasting, over-reacting to fouls and general irritancy, all designed to run down the clock, disrupt United's rhythm while

ultimately seeing them through to the next round.

With 25 minutes left, Rangnick made a triple substitution, bringing on Marcus Rashford, Nemanja Matic and Paul Pogba to try to gain some semblance of control and plunder the goal they needed, a task which proved beyond them.

Simeone was pelted with bottles as he raced to the dugout at full-time, a real night to forget for the red half of Manchester.



PAINFUL NIGHT Fernandes is consoled



BIG CHALLENGE Emery

Emery: We want a stable Villa in the CL

UNAI EMERY has called on his Villarreal side to be remembered for their achievements in this season's Champions League - starting with a win in their last-16 showdown away to Juventus tonight.

The teams are level at 1-1 heading into the second leg in Italy.

And boss Emery said: "We don't want Villarreal to be something

» JUVE v VILLARREAL

TONIGHT, 8PM, AGG 1-1

BY ALAN MARSHALL

ephemeral in the Champions League, we want to be here to stay.

"Winning against a club like Juventus means the chance to keep competing at a European level."

Juve have not reached the

quarter-finals for the past two seasons and boss Massimiliano Allegri urged his players to treat the match like a final.

He said: "The only goal is to qualify. This is the moment that counts. It will be like a final."

"Since away goals no longer count double, we have to win and that's it."



YOUR VOICE OF THE HIBES EVERY WEEK IN RECORD SPORT

TAM McMANUS



CONFIDENT Robbie Neilson

I've not been this excited since Jason's left peg 'opened a tin of beans'

THE SECOND CUMMINGS

SUPERHEROES are a bit thin on the ground in Scottish football.

That may all be about to change as I believe Hibs have found a Captain Marvel after Elias Melkersen at last announced himself with a brilliant weekend double at Motherwell.

I've not been this excited about a young striker emerging at Easter Road since Jason Cummings claimed his left foot "opened up a tin of beans" after his goals at Hamilton in the play-offs a few years back.

Melkersen arrived in the summer with a big reputation from Bodo/Glimt. But he was kept in the background before making his debut as a late sub in the goalless draw with Dundee last month then given a run from the bench in a stalemate with St Johnstone.

After watching him score twice at Fir Park to put Hibs into the last four of the Scottish Cup, he's been more than worth the wait.

Hibs paid a six-figure fee, he was the buzz signing of last summer then it all went quiet. It's a lot of money for a guy who'd apparently never played the game on grass before.

All we'd seen of him was what was on his goal compilation video and that was enough to have fans convinced

HERO AND VILLAIN
Cummings and Hurtado



they had a player on their hands. It appears there have been a few injury issues and maybe the management have been keeping him on a tight rein.

But he was let off the leash at Motherwell and was outstanding. Two goals, great movement and clinical finishing, this boy is only 19 and he just looks like a player.

You can tell straight away with guys like Melkersen – the way he moves, the intelligence and the calibre of his finishing.

It was two chances and two goals and he has fans anticipating more of the same over the next couple of months.

What Melkersen offers is something different for Hibs. I watched his touch and how ruthless he was with the way he took his second goal. Hibs have been desperate for someone, anyone, a superhero to come in and score goals.

And for Melkersen to do it in front of 3500 of his own fans and in such a big game is an instant impact.

It couldn't be timed any better with Kevin Nesbitt injured and it's also going to give

the other strikers something to think about if they want to keep their place in the team.

He looks hungry. He reminds me of myself when I came through at Hibs. Like the other young strikers emerging at that time, it was a desperation to score goals.

Not all signings display that appetite. Eduardo Hurtado from Ecuador arrived with a big reputation after scoring goals all over South America.

He wasn't a flash in the pan, he was more flushed down the pan and remains the worst footballer I played with. Honestly, he was hopeless. I remember he came into Hibs and trained in the morning and I watched him with my mouth open in shock.

Sometimes you get guys who are poor in training but come alive in games. But sadly not the bold Eduardo.

What a Scottish Cup draw. I was amazed to hear the two big Glasgow and Edinburgh clubs have never been all together at this stage of the competition and now we have two cracking games to look forward to.

Hibs could possibly play Hearts three times in April if they get into the top six. These are the games that make or break you both as a player and a manager. It's the ultimate chance for Shaun Maloney to endear himself to a support where there's nothing better than beating Hearts.



ELIAS GETS A CAP CALL

ELIAS MELKERSEN has followed up his Scottish Cup double with a call-up for Norway Under-20s.

The 19-year-old marked his first start for Hibs with both goals in the quarter-final win at Motherwell.

Now the January signing from Bodo/Glimt is to join up with Jan Peder Jalland's squad next week for UEFA Elite League games against Romania and Italy.

HIBS' NEW SUPERHERO
Elias Melkersen

BOYLE HAPPY TO PLAY IT COOL IN SAUDI

MARTIN BOYLE insists he's enjoying the change of pace in Saudi Arabia – saying he doesn't miss the "abuse" he got from fans while at Hibs.

The Australia winger swapped the SPFL for Al-Faisaly in January and

has already notched two goals for them. His wife Rachel – the Hibs women star – and daughter Amelia remain in Edinburgh.

Boyle finds it's difficult to be so far away from his family.

But he said on the Football Australia podcast: "I don't miss all the crunching tackles I

got every Saturday playing for Hibs and the abuse from fans.

"It's a bit more timid in Saudi Arabia. I've been on the end of a few challenges but they just play on here. I'm not complaining, I'm one of those players who just gets on with it.

"My daughter tells me

every week how many goals she wants Daddy to score.

Sometimes she'll say 'five!' Sometimes it'll be one or two.

"She keeps asking when she can come and watch Daddy play which is a bit upsetting but I'm sure in the near future she can come out and see everything."

Neutral venue hoodoo for Hibeers
HIBS will have to overcome yet another Scottish Cup hoodoo if they are to reach this season's final. The Easter Road side, who ended their 114-year wait for the trophy in 2016, have never beaten Edinburgh rivals Hearts at Hampden, or any neutral venue, in the competition dating back to the 19th century.

Rob: Show you have the Heart

BY ALAN MARSHALL

ROBBIE NEILSON has urged Hearts to meet expectations and beat rivals Hibs next month to reach the Scottish Cup Final.

The Jambos gaffer insists a club of the stature of Hearts should be reaching finals and getting their hands on silverware, and is hoping for a repeat of their 2020 semi-final triumph over their Edinburgh foes.

Hearts are enjoying an impressive campaign and look to have an unassailable 13-point lead in third place in the Premiership.

Neilson is now desperate for his side to prove themselves in the Cup by sealing a knock-out victory against their city neighbours to give themselves a shot at winning the trophy.

He said: "This is where we expect to be with a club of Hearts' stature.

"We should be challenging at the top end of the league, getting to cup semis, finals, and winning the trophies.

"Yes, it has probably happened quicker than we all expected. The first season back in the Premiership is normally about stability and then building.

"But we have got a good group together. Momentum is there.

"The fans get excited, as the players and staff do as well. It's what you want."

Rivals can KO Hearts hopes

HEARTS will be guaranteed group stage European football next season – as long as Hibs don't win the Scottish Cup.

The Jambos can secure a third-placed finish before the split – with the potential to confirm their best of the rest place against their Edinburgh rivals.

If Hearts, Rangers or Celtic win the Cup, the Jambos will be parachuted into the Europa League play-off qualifier with just one tie to play in order to make the group. Lose and they'll be in the Europa Conference League.

But if Hibs lift the trophy they'll bank the prize money and group stage football.



DUNDEE UNITED

LATEST



DREAM MATCH McKinnon

Cole: Derby is going to B amazing

BY FRASER WILSON

RANGERS teenager Cole McKinnon insists he'll be realising a lifelong dream to play in an Old Firm at Ibrox on Saturday – even if it's a B team derby.

David McCallum's Lowland League side take on Celtic in a second-string encounter which is set to attract a bumper crowd with Gio van Bronckhorst's first team not in action until 24 hours later.

Midfielder McKinnon can't wait to get a taste of the Ibrox atmosphere after the game was switched from the reserves' usual base in Dumbarton.

Thousands are expected to turn out to watch.

And McKinnon said: "I can't wait. I've been a Rangers fan my whole life so it is a dream come true to play at Ibrox – especially to play in an Old Firm match. Ever since the game was scheduled we've all been buzzing."

McKinnon, 19, spent last season on loan at East Fife but has returned to be a steady performer for McCallum's young Gers.

Gaffer McCallum, meanwhile, has challenged his B team stars to rise to the big occasion.

He said: "Playing in front of the fans at Ibrox is an added incentive for the boys to reach the levels we believe we can."

"The environment will be different with the amount of supporters. It is a unique experience but we want them to get used to it. We want to put on a positive performance that puts us on the front foot."

Pars salute Cup legend Jackie

DUNFERMLINE have paid tribute to one of their 1961 Scottish Cup-winning legends following the death of Jackie Williamson aged 89.

In that Scottish Cup Final he twice ignored knee injuries to help the Fifers to a goalless draw against Celtic. The pain stopped him from turning out in the rematch, which Dunfermline won 2-0.

A Pars statement read: "He remained, as he was that day at Hampden over 60 years ago, a warrior right up to the final whistle."



Freeman: I had plenty of time to see Reo's challenge coming but...

I'll not put the boot in

FREE HIT
Ref Beaton goes to book Celtic's Hatate for his tackle on Freeman

KIERAN FREEMAN was braced for Reo Hatate's steaming challenge.

But the Dundee United midfielder refused to join the stampede calling for the Celtic star to be sent off.

Freeman was clattered by the Hoops man in Monday night's Scottish Cup defeat.

It was 1-0 to Celtic at the time and United fans howled for John Beaton to brandish a red card – with Calum Butcher getting hit with a retrospective two-game ban for a similar lunge on David Turnbull when the sides met earlier this season.

Freeman said: "I knew it was coming. I got the ball and tried to play it inside."

"These things happen. I'll leave that to others to discuss. I was in the heat of the game and didn't see too much."

"How much did he catch me? I'm not sure. I felt contact and it's up to the referee to do what-

BY MICHAEL GANNON

ever he thinks. I was down on the ground. I didn't know what was happening around me and you can't change that now.

"He gave the yellow and I don't think it impacted on the game too much in the end."

"I'd plenty of time to see that coming and it is what it is."

Freeman didn't see the Benji Siegrist gaffe coming though for Celtic's crucial second goal. The keeper spilled a Daizen Maeda

cross to gift Giorgos Giakoumakis but no one in the United dressing room will point the finger.

Freeman said: "Benji has done a lot more good than bad. He's saved so many points for us. He's disappointed but there's no reason for him to be. It's not his fault at all."

"It happens to everyone. You see the top goalies and mistakes like that happen to them."

"You can trace it back a lot further up the pitch so it's not

just Benji's fault for that goal. He's a very good keeper and has done superbly well for us."

"There's no blame on Benji. He'll already be looking forward to St Mirren on Saturday and putting it right as we all are."

Freeman was gutted at the Scottish Cup exit but insisted United can get stuck in to a thrilling end to the season with a top four place still up for grabs.

He added: "The season's not over. There's plenty to play for. We're striving to get in the top six and have three games to do that."

"We can still have a good season. Fourth place is still absolutely achievable for us and that's what we're looking to do."

"We've got three games before the split. Every game is vital to us. We need to be going

down to Paisley to pick up three points to put ourselves in a good position."

"First and foremost, getting in the top six would be a successful season. Anything else would be a huge bonus."

"We're still in the race for a top-four finish with three games before the split. We'd have taken that at the start of the season."

United fans packed out three sides of Tannadice for the Celtic clash and Freeman wants the punters on board for the big push. He said: "Hopefully our fans can back us like they did tonight and hopefully it's a good Saturday down in Paisley."

"On a Monday night, given the ticket pricing, it was a really good effort from our fans. It's just a pity we didn't put on a better performance and get a result."

"Hopefully we'll do that on Saturday and they can forget about the Cup game."



UNHAPPY United players crowd Beaton after challenge by Hatate, right, on Freeman, far right

IRON MAN MAHON STEELS SAINTS' BACKLINE

HE has been restricted to cameo roles from the bench.

But St Johnstone boss Callum Davidson says January recruit John Mahon has already stiffened his Perth backline.

The Irish central defender was lured from Sligo Rovers for a six-figure fee.

But he has had to be patient with skipper Liam Gordon and Jamie McCart getting back to last

BY GORDON BANNERMAN

term's cup double winning standards, alongside Dan Cleary or James Brown.

"I'm absolutely delighted with John," said relegation-battling Perth boss Davidson.

"He came over during Ireland's pre-season and has been a fantastic character around the place."

"The back three have stepped it up performance-wise since the

break so it's been difficult for him to get in the team.

"John has put pressure on them and I think he's looked strong and aggressive when he's come on."

"I'll have absolutely no qualms about starting him."

"He won't be fazed when I throw him in."

Davidson has also been delighted with the impact made by ex-Falkirk wingback Tony

Gallacher since arriving at Perth from Liverpool.

"Tony's improving all the time," he said. "It's all about playing games at this stage of his career."

"He's got all the attributes you need for that position and has performed well. It puts pressure on Callum Booth, who's had things his own way this season – but having competition will certainly improve his performances."



HAS NO FEAR John Mahon



RANGERS



RED WARNING Souness hopes GVB is ready for Serbs

SOUEY: DON'T THINK IT IS ALL TIED UP GIO

RANGERS legend Graeme Souness has warned Gio van Bronckhorst and his players their 3-0 home win over Red Star Belgrade last week does NOT mean that they're guaranteed a place in the quarter-final draw.

The former Ibrox player-manager saw the Serbians have two goals disallowed by VAR, miss a penalty and hit the woodwork in the first leg and he fears that a good start by them in front of a hostile crowd could see that three-goal lead disappear.

He still believes his old club can progress to the final but admits that even a three-goal lead might not be enough if James Tavernier and Co can't keep it tight at the back.

"I'm not counting any chickens yet because this tie isn't over," claimed Souness. "They still have a hard job to do in Belgrade. This team is capable of scoring goals, as they proved in the first leg.

"If I was managing Rangers at this time I'd be telling the players that if Red Star get an early goal their tails will be up and we'll have a real game on our hands.

"They need to start in the right manner and try to quieten the crowd, get to half-time at 0-0, make them nervous.

"Red Star are a threat,

More time with Colombia

RED-HOT Rangers striker Alfredo Morelos has been named in Colombia's squad for their upcoming World Cup qualifiers with Bolivia and Venezuela.

And it's a prime opportunity for El Bufalo to avenge a nightmare trip to South America in

BY EWING GRAHAME

though. Some marginal decisions went against them at Ibrox.

"Look, 3-0 is a healthy lead to take into any return game but it doesn't mean the tie is settled."

Souness, though, knows what it would mean to Rangers' reputation if they could go all the way in the competition.

"It would be enormous," he insisted. "In England and further afield, the only game that resonates is the Old Firm derby so Rangers doing as well as they have done in Europe makes everyone sit up and take notice – and that can only be good for all of Scottish football.

"It's selfish talking about Rangers being a more attractive club when it comes to them signing players – although they're still the priority, as far as I'm concerned – but it should help other Scottish clubs as well."

● Graeme Souness, along with former Scotland team-mates Joe Jordan, Alan Rough and Frank McAvennie, raised over £100,000 for DEBRA at a dinner in Glasgow on Sunday. The charity was founded to help children suffering from epidermolysis bullosa, a life threatening skin condition which is currently incurable. For more info go to debra.org.uk.

January as he wasn't included in the matchday squads against Argentina and Peru.

Morelos won't miss any club fixtures this around and he will be hoping for competitive game time before returning to take on Celtic on April 3.

THE BE ALL AND END HALL OF FAME

Tav deserves place in pantheon of greats after leading Gers to greatest ever title says Stewart

IT'S perhaps no surprise the Rangers Hall of Fame has kept its doors firmly closed for the past eight years.

A virtual venue open only to the greatest players to have pulled on the light blue, it bears the names of Govan goliaths such as John Greig, Ally McCoist, Graeme Souness, Willie Henderson, George Young... the list goes on.

That Lee McCulloch, Nacho Novo and the late Fernando Ricksen were the last inductees in 2014 tells its own story about a near decade in the doldrums.

But now, after an incredible unbeaten league campaign that saw Rangers become champions again, the debate over throwing open that gateway to greatness is raging among fans once again.

Front and centre of the debate is the man who led Steven Gerrard's side to that 55th title – and who finds himself pivotal to the push for more glory on the domestic and European fronts.

James Tavernier has ridden the

EXCLUSIVE
BY FRASER WILSON

rough with the smooth and former Ibrox forward Greg Stewart has marvelled at his leadership qualities.

As a team-mate Stewart saw Tavernier singled out for flak when a title tilt went awry after the winter break two seasons running.

But the Englishman kept producing the goods. In seven seasons Tavernier has struck 77 goals in 332 appearances from right back. A sensational figure

bolstered by his equally important 105 assists.

Stewart reckons the 30-year-old has already achieved legend status by securing a title he reckons is one of, if not THEE, greatest in the club's history.

There are others close to that list of greats too, he reckons, including Alan McGregor, Alfredo Morelos and Connor Goldson whose remarkable consistency saw him play every single minute of the title-clinching campaign.

Speaking to the Record Rangers podcast Stewart said: "In my

opinion they won probably the greatest title in the club's history.

"You have to remember all these other Hall of Fame guys always played with top players and top Rangers teams in the Champions League.

"Tav has not had that standard beside him all the time at Rangers. Right now is probably the highest standard he's had in terms of quality. You probably won't realise how good Tav is until he's gone.

"It's the same with Connor Goldson. Rangers fans won't appreciate how good these two

GREG CELEBRATES INDIAN LEAGUE

GREG STEWART waited 11 seasons as a professional footballer to get his hands on a league winners' medal then two came along in the space of a year – exactly a year to be precise.

Incredibly, 365 days on from Rangers being confirmed as Premiership champions in 2021 the forward was celebrating again as Jamshedpur upset the

odds to lift their first ever Indian Super League.

A 1-0 win against Mohun Bagan was enough to secure it on March 7 – a date Stewart could be forgiven for circling on his calendar for the rest of his days.

The 31-year-old struck an impressive 10 goals in 20 matches, including a sensational free-kick against Kerala Blasters

that went viral online, after being tempted to make the 5000-mile trek to Goa by Jamshedpur manager Owen Coyle.

But while making history in South Asia will always have a proud place in his career achievements, Stewart insists nothing will compare to the heights he scaled 12 months earlier with Rangers. He said: "It



CAPTAIN IN WITH LEGENDS



Stankovic: Fightback win top prep

RED STAR boss Dejan Stankovic insists their comeback league win will set them up perfectly for the visit of Rangers.

The Serbian champions were 1-0 down at Matalac on Monday night before goals from Ohi

Omoijuanfo and Milan Pavkov earned them a 2-1 win.

As they bid to claw back a 3-0 deficit against Gers, Stankovic said: "We will need the same character and it was great preparation. This team never

gives up. It will be a completely different game against Rangers.

"It will be in front of a full Marakana and everyone knows what a difference that could make. It's vital the whole stadium gets behind us."

TERRIFIC TAV
Gers skipper Tavernier, left with Morelos, has been tipped for Hall of Fame

are until they've left. Tav is a great guy, a great captain and he's shown that on the park recently.

"He has been there through some tough times. I love to see guys like that succeed."

"When Tav got to lift that trophy he deserved it more than anyone because of the tough times he has overcome. He is never too high and never too low. He's calm in the head and always pushes his team-mates to give their all.

"When you see guys like that lifting trophies for Rangers - there's nobody more deserving. I'd love to see him lift

another couple this season. McGregor is the same. You hear the daft stories and all that stuff is great.

"But nobody really speaks about his routine - there's nobody in the club like him. He's just on it every day.

"A top professional and that's why he's still playing at the level he is.

"You go in in the morning, and there were times I thought I'd be first in, but there was Greegsy doing his thing - strengthening, stretches, core stuff. That's before he goes out to the training ground.

"I don't see why he can't go another season. But

he will just be thinking about now - and getting another title."

Stewart - now celebrating another title success with Jamshedpur in India - has been responsible for setting up a new, unofficial, branch of a Rangers supporters' club in his Goa base alongside No.2 Sandy Stewart.

The Ibrox side's charge to the last 16 of the Europa League has seen them bouncing around his living quarters at 3am on a Friday.

Now he's bracing himself for another late night as Gio van Bronckhorst's side look to burst through the glass ceiling of the last few seasons and into the land of possibility in the quarter-finals.

Stewart said: "Me and Sandy have been up to three and four in the morning watching the lads.

"We've been jumping about the room celebrating goals in the middle of the night while boys are sleeping next to us. Are they contenders to go all the way? Yes, definitely."

WIN WITH ANOTHER

was quite weird as I didn't know the day we won the league out here was exactly a year to the day that we won the league with Rangers.

"I only realised we'd won it on the same day - March 7 - this year after the game. So it was a good day.

"This team has never even been in the top four before so

to manage to win the league is a pretty big thing.

"But the celebrations certainly never matched last season's scenes at Ibrox.

We're in a bubble, in a hotel resort, so we've only been able to enjoy a few beers. But it's been great."



DELIGHT
Stewart

Gers shape fixture feast

RANGERS are poised for a box office run of fixtures that is set to include THREE showdowns with Celtic.

And the Ibrox side could also be in line for a trio of Europa League fixtures in April if their stirring run on the continent continues by finishing off Red Star Belgrade, leading to a pair of quarter-final ties on April 7 and 14. Here is the run of fixtures if everything goes to plan...

Rangers' potential April fixture list
April 3: Rangers v Celtic (H) - Scottish Premiership
April 7: Europa League quarter-final first leg (TBC)
April 10: St Mirren v Rangers (A) - Scottish Premiership
April 14: Europa League quarter-final second leg (TBC)
April 17: Celtic v Rangers (H) - Scottish Cup semi-final
April 23/24: Potential clash with Celtic (A) - Scottish Premiership Matchday 34
April 28: Europa League semi-final first leg (TBC)



BOOTROOM

DAILY POLL

WILL Rangers score in Belgrade in their Europa League second leg tomorrow?

QUICK QUIZ ?

1. From which club did Arsenal sign Ghana midfielder Thomas Partey?
2. Who claimed Britain's first medal of the Tokyo 2020 Olympics?
3. What nationality is golfer Viktor Hovland?
4. Franklin's Gardens is home to which Gallagher Premiership side?
5. In which year did Rafael Nadal win his first grand slam tennis singles title?
6. Who captained England Women to Cricket World Cup glory in 2009?
7. Which venue will host rugby league's Challenge Cup final in May?
8. Which British duo won gold in the women's coxless pair at both the 2012 and 2016 Olympics?
9. Tom Brady has so far made how many touchdown passes in his NFL career - 604, 614 or 624?
10. Who will captain Team USA at next year's Ryder Cup in Italy?

ON THIS DAY



2001: George Graham was dismissed as Spurs manager following a meeting with new executive vice-chairman David Buchler. He had been in charge for two and a half years.

TV SPORT



FOOTBALL:
Champions League, Lille v Chelsea (BT Sport 2, 7pm), Juventus v Villarreal (BT Sport 3, 7.30pm); Premier League, Arsenal v Liverpool (Sports Premier League 7.30pm); Championship, Millwall v Huddersfield (Sky Sports Football 7pm).
HORSE RACING: Cheltenham Festival (ITV 12.50pm).
CYCLING: Nokere Koerse (Eurosport 1, 11.30am, 2.30pm).

GOT A STORY?

📧 Tweet us at @Record_Sport
Or email us sport@dailyrecord.co.uk

ANSWERS: 1. Atletico Madrid; 2. Chelsea; 3. Norwegian; 4. Northampton Saints; 5. 2005; 6. Charlotte Edwards; 7. Tottenham Hotspur Stadium; 8. Helen Glover and Heather Stanning; 9. 624; 10. Zach Johnson.



SUPER SAINT Declan McManus

Declan: I'd love crack at Old Firm in Europe

EXCLUSIVE
BY SCOTT BURNS

DECLAN McMANUS has helped fire The New Saints to the Welsh title and would love a tilt at Celtic or Rangers in the Champions League.

The prolific Scot has more than played his part as his 27 goals in all competitions have helped TNS land their first JD Cymru Premier Trophy in three seasons.

McManus and his team-mates clinched it after a 3-3 draw with Penybont at the weekend.

It means the Welsh side can now look forward to next season's Champions League, where they will go into the first qualifying round and if they could go on a run could potentially face Rangers or Celtic, whoever finishes second, in the qualifiers.

McManus said: "We are now in the Champions League qualifiers.

"I know it isn't the group stages but it is still a wonderful achievement for us as a club.

"We know we'll be coming up against some really good clubs and we can look forward to that.

"Ideally, we want to get as far as we can but we are not stupid and are aware of some of the calibre of clubs we could come up against.

"There will be massive teams with massive budgets and it could be somebody like Celtic or Rangers.

"If we were drawn against them then we would snatch your hand off. The big thing for us is getting into the Champions League."

The 27-year-old knows a lot of eyebrows were raised when TNS decided to pay a five-figure sum to take him from Dunfermline last term.

A lot of people also questioned why McManus would want to go to Wales but he believes his decision has already been justified.

The former Aberdeen and Ross County frontman said: "I have had a taste of European football, that was a big pull. I have played Championship football most of my career and I fancied something different.

"That excited me along with the chance to win trophies in another country."



CELTIC

BY MICHAEL GANNON

MATT O'RILEY knew Callum McGregor was a top man the minute he walked in the door at Celtic Park in January.

But it was when the skipper braved a broken face to take on Rangers that the new recruit from MK Dons realised the long serving Celt was a proper leader of men.

O'Riley has hit the ground running since his bargain £1.5million switch two months ago and a lot has been down to the captain making him feel right at home.

The playmaker – who was yesterday called up by Denmark's Under-21s – can see it's McGregor who makes the Hoops tick.

He sets the tone in training, supports the side while laying out the demands.

But more than most, McGregor leads from the front.

The 28-year-old was at it again at Tannadice on Monday night as Celtic cruised in to the Scottish Cup semi-finals and set up a collision course with fierce rivals Rangers.

McGregor ran the show all night and grabbed the crucial opening goal to send Celts on their way as a potentially tricky evening at Tannadice turned out to be fairly stress free.

The same can't be said about the coming weeks.

The Parkhead club are gearing up for an epic April – which could incredibly contain THREE Old Firm showdowns.

Ange Postecoglou's men are on Premiership duty at Ibrox on April 3, they will clash again at Hampden on the 17th and are likely to meet for the final league encounter at Parkhead in the first few games after the split.

Things are about to get wild but O'Riley is feeling more relaxed with his McGregor around as he admitted the sight of the skipper in the iron mask against Gers last time out was inspirational.

O'Riley said: "Yeah. It wasn't a game he was going to miss was it? He does bring that assurance and calmness to the team, a real presence. "He's been involved in so many

THE IRON MAN IN THE MASK

O'Riley has loved working with classy Cal

games so having him there is so important.

"He's top. On my first day he welcomed me really nicely so from that moment on I could see he was a proper man, a proper guy.

"He steps up every day in training. He always drives it, always demands the best from himself and everyone else. He's a proper captain."

McGregor could be leading Celtic towards something pretty special this season.

There are major hurdles in the way with an Old Firm triple header to be negotiated if the Hoops are to hang on to hopes of a treble.

But the fact there's even talk of a clean sweep at this stage is remarkable given the base point Postecoglou

had to jump off last August. Three defeats in his first six league games looked to have strangled the title bid before the clocks went back.

But since losing at Livingston last September, the big Aussie's side have racked up 30 domestic games unbeaten to fire themselves in to the frame to make history.

O'Riley didn't bat an eyelid when the Scottish Cup draw was made because the manager has got the squad convinced they are a match for anyone.

The 21-year-old said: "That's the mindset we have, it has to be like that. It comes from the manager. He really believes we can beat anyone and that transfers to the boys.

"You see it on the pitch, we really believe in ourselves."

Celtic have turned on the style at times this term but they've also found different ways to win over the 30-game run.

O'Riley admitted they went through a spell when it was a bit of

a grind but he feels the side are hitting top form again right in time for the business end of the season.

He said: "We spoke about it. The level dropped a little bit performance wise. It can happen for whatever reason. There's been a lot of games this season already.

"But we rectified it quickly. The training standards have always been really high. As long as we drive that each day it will translate to the pitch."

O'Riley wants to keep the foot down but he'll do his best to leave the talk of the clean sweep for others.

It was job done on Tayside and he'll look forward to Hampden but the schemer won't take the eye of the ball before then.

He said: "Everyone is aware of it at the back of our minds.

"But if you look at it from that point of view you can get distracted from the task ahead – which is Ross County.

"You are better off if you stay in the moment and focus on game by game."

“On my first day he welcomed me so from then I could see he was a proper man, a proper guy”

MATT O'RILEY TELLS OF HIS ADMIRATION FOR HIS CAPTAIN

MATT: I'M LOOKING FORWARD TO 50-50 SPLIT - A BIT OF

FROM BACK PAGE

of Rangers at a pulsating Parkhead last month as 60,000 punters partied while their rival fans were shut out.

Hampden is set for a 50-50 ticket split and O'Riley reckons the Hampden heat will make the clash even more intense.

The former MK Dons ace helped book the last-four berth with the 3-0 win at Dundee

United on Monday and he said: "I'm actually really looking forward to that 50-50 split. It will probably create an even better atmosphere – with a bit of hostility towards both teams.

"I enjoy it, that's what I buzz off. We'll be ready for it when the games come around.

"These are the games I look forward to most. They are the games you are under the most

pressure, you have to demand the most from yourself and the team. I'm really looking forward to it.

"It should be good at Hampden. I've watched the cup final highlights from last time and I've seen how crazy the stadium looked. I'm definitely excited about it."

Premier Sports Cup winners Celtic have a Treble in their

sights with a three-point lead at the top of the Premiership and the Scottish Cup at the business end.

O'Riley is determined to stay focused on Ross County in the league this weekend but it's impossible to ignore the prospect of an epic April that could include three showdowns with their fierce foes. Celts head to Ibrox on league

duty on April 3 and the rivals square up at Hampden two weeks later. And they could meet again soon after with the clubs likely to be paired up early after the split.

Asked about embracing the unique situation, O'Riley said: "You're not wrong. But these are the games we are all buzzing to play in.

"For myself, I just love

» PUT TAV IN GERS HALL OF FAME

SEE PAGES 46&47

NEW BHOY HAILS SKIPPER



MASKED MAGICIAN
Calmac was in his usual top form during Celtic's win over United

BHOYS' CLUB
O'Riley has raved about how Calmac has galvanised his Celtic side

HOSTILITY FOR BOTH TEAMS

playing in that atmosphere where it's bouncing. It makes you want to play better."

O'Riley won't be fazed by the Old Firm cauldron after being inspired by it last time.

The youngster revealed his parents could hardly believe what they saw at Parkhead when they were in the stands last time the sides collided and he's out

for more of the same. O'Riley said: "It was spine-tingling.

"I spoke to a few people and they said it was probably one of the craziest Celtic v Rangers atmospheres there's been, which was pretty cool. I was grateful to be part of it.

"I don't think that you understand how crazy it is unless you're in the stadium. "It looks amazing on TV

but it's not until you are in there. My mum and dad were in the stadium and they were thinking, 'Wow, this is crazy'.

"It has to inspire you to want more. The fans make it what it is. You're up for every game but when you have the fans behind you, it gives you that extra 10 per cent."

Hotline

» MICHAEL GANNON ANSWERS YOUR CALLS

WE'RE ploughing towards the business end of the season and a few VARS are going to get even more twitchy with the double derby Scottish Cup semi-finals on the horizon.

Think things are controversial now? Hold my beer March, April is on the way. The Old Firm and Edinburgh duo will collide at Hampden but some don't think our refs can be trusted to make the right calls.

Robert McEwan, Mount Vernon, said: "We should bring in VAR for the Scottish Cup semi-final games.

"The four teams involved can chip in for it, but I won't hold my breath."

At this rate there will be robot refs around the world by the time we get VAR.

In the meantime it's conspiracies that rule in these parts after another controversial night at Tannadice.

Joe Smith, Coleraine, said: "I don't think Celtic have had a decision go against them that resulted in them dropping points since Ian Bankier's speech at the Celtic AGM.

"There have been plenty of decisions given against Rangers - to the tune of around 13 points.

"Carl Starfelt should have conceded a penalty, Reo Hatate's out-of-control studs-up tackle should have been a red card.

"VAR would have corrected these atrocious decisions. A paranoid person would say there was an orchestrated campaign afoot."

Tom Gibbons emailed: "If Hatate's impersonation of a runaway train had not been stopped by Kieran Freeman's right foot, he probably would've ended up at Dens Park 200 yards down the road! What was ref John Beaton thinking?"

But **Henry Moffat, Stirling**, said: "As yet another

QUOTE OF THE DAY

'VAR would have corrected these atrocious decisions. A paranoid person would say there was an orchestrated campaign afoot'

good Celtic goal is chopped off, when are Rangers fans going to stop boring everyone with this hard done to by refs nonsense?

"It's just like their 150th birthday celebrations, no-one is taking them seriously.

"The only thing that needs looking into is the Ryan Kent flick kick trick which it seems everyone has had enough of."

Brian McColligan, via email, said: "As a Celtic fan I can't wait for VAR to come in. Once again a good goal chalked off for Celtic whilst Rangers are awarded their usual dubious penalty. Bring it on."

Gordon Ashley, Ayr, said: "What a joke to rule out yet another clear Celtic goal on Monday by a referee who has shown several times this season that he understands the rule involved.

"Celtic must contact UEFA to complain about referee intimidation by a certain club's fans and pundits as we would be six points further in front if VAR was in play."

Mark Smith, Cumbernauld, hit back and said: "I wondered how long it would take for **Hotline** blowhard Gordon Ashley to complain about Kent and again typify Celtic's mentality of criticising refs in time for the next Old Firm game - bring in VAR now!"

The fight for silverware is on and **Eddie Easson, Ballingry**, said: "The media are talking up a Celtic Treble for one reason and one reason only. They are the only team that can do it.

"But Trebles aren't won in March, there's 10 games to go to achieve it. Big Ange has all his team singing from the same songsheet. One game at a time."

Bud Hay, Dumfries, sees it differently and said: "Aaron Ramsey is on about Rangers in three competitions. We will see how many they are in when they come to Paradise."

WELCOME MATT
O'Riley and Giakoumakis

HAVE YOUR SAY ON THE BIGGEST ISSUES IN SPORT AND EMAIL:
hotline@dailyrecord.co.uk



SCOTLAND

STEVE: DON'T HIT US FOR 6

FROM BACK PAGE

winner then facing either Wales or Austria for a place at Qatar 2022.

But, as it stands, Clarke's men also have four Nations League matches to fit in at the end of the season.

And the manager suspects FIFA – under president Gianni Infantino – and UEFA are on the verge of making a typically botched decision rather than go to the bother of ripping up and redesigning their own fixture lists.

Clarke said: "We hope and pray that we are playing Ukraine in the semi-final play-off in June.

"But what happens with the rest of the month, I don't know.

"All the big wigs are still in discussions and trying to find a solution. There's fixture congestion that will arise from this.

"At the moment I'm desperate not to be in a position where we might have to play six games in June because that would be too much for the players on the back of a long hard season.

"At the moment that seems to be the thinking – that we might need to squeeze six games into a June window which is not correct in terms of player welfare.

"Just the timing of it, on the back of a long hard season. Even a four-game window was going to be a little bit unusual in the Nations League.

"But to try and squeeze in a play-off semi-final and hopefully a final? That would take it to six games which is too much. I think those are the discussions they are having.

"You've got to put it all into context in terms of what Ukraine is suffering at this moment. These are sporting matters but Ukraine could also be in a position where they might have to play six matches.

"The people who organise the fixtures and the international calendar



BIG CALL Gianni Infantino

have shown before that, in certain circumstances, they can move the fixtures around.

"Maybe this is a case where they are going to have to help us out."

At this stage, with their country under savage attack, there is no way of knowing if Ukraine will be able or remotely willing to play a match in June.

But Clarke went on: "The most important thing for me is that we do get a chance to play against Ukraine.

"I'd like to think that the situation resolves itself enough for Ukraine to get a team on the pitch in June. But you have to look at the situation and think that could be difficult.

"On a human level I hope the game goes ahead as that will mean the situation has improved dramatically and that's what we're all hoping for."

Clarke's team will face Poland at Hampden next Thursday in a friendly fundraiser for the humanitarian drive on the ground in Ukraine before facing the losers of the other play-off semi between Wales and Austria

And he knows the watching world will be willing his opponents on – in the increasingly unlikely event that the play-offs do go ahead at the end of the season.

He said: "I appreciate they'll have the emotional support of most people. But we want to go to the World Cup as well.

"So from a sporting point of view, we'll be ready for the challenge."

THE world has changed considerably since Steve Clarke last took charge of his Scotland side.

Given what has gone on over the past few weeks, a sense of perspective has settled over the progress of our national team, like a huge dark cloud.

What seemed back then like the most important thing on the planet – qualification for a Qatar 2022 – now feels like an almost grubby, completely out of kilter wish at a moment when real-life carnage is being unleashed against the nation that stands in Clarke's way.

But, albeit a little awkwardly, the Scotland manager has to get on with his own job of planning for a match that probably will never happen against a country with a more important matters on its mind.

No such worries existed at the end of last year when Clarke and his players were riding high into the play-offs, off the back of a stunning run of results.

Now, rather than take on Ukraine next week for a place at the World Cup, they will take part in a fundraising friendly against neighbours Poland.

Against such an appalling backdrop of human tragedy and suffering, the loss of Scotland's feelgood factor is a casualty we can all live with.

But nevertheless it's the manager's job to bring it back.

"Yeah, we were in a good place in November," said Clarke with a nod to happier times.

"The run of six wins was good. To finish here with a win against a good Danish team and another full house at Hampden..."

"Everyone was excited and looking forward to the play-off game. It was a great place to be.

"But circumstances have changed so we have to adapt a little bit and we will adapt this month in sporting terms by playing two friendly matches.

"We'll just try to keep improving. Hopefully we can hold on to our unbeaten



FULL-BACK IN Patterson and Hickey

BY KEITH JACKSON

run and try to keep a bit of momentum going into the June games."

What that end-of-season schedule looks like remains up in the air. FIFA and UEFA have been left to make things up as they go along to accommodate the consequences of the ongoing crisis.

It could be Scotland are asked to play six games in one month to fulfil their scheduled fixtures – a scenario Clarke is not prepared to swallow on the grounds of fairness and player welfare. But in the meantime he is looking forward to getting his group back together again and hoping as soon as they are, everything will fall back into place.

Clarke said: "I hope so. Obviously I've been in touch with one or two of them over the long break and the general feeling is that they want to get back together and see their mates, catch up a little bit and start preparing for the games coming up."

And yet there are issues to resolve. Back in November Nathan Patterson was the breakthrough kid with the world at his feet and a £16million move to Everton on the horizon.

Now Patterson may be in need of a cuddle, having left Rangers only to find himself even more frozen out of first-team football than he already was but with a team hurtling

towards relegation and under new management.

No surprise then that Aaron Hickey – a Serie A standout at Bologna – has been included, despite previously turning down call-ups for the Under-19s and 21s under strict and misguided instruction from his father.

Clarke has brought the former Hearts kid in to stiffen up his options at right-back with doubts persisting over Patterson's form and confidence.

The manager said: "Hickey is adaptable. I've seen him playing a couple of games off the right for Bologna and he did okay.

"He can play off the left. In our group he's obviously got competition with the captain Andy Robertson and Kieran Tierney in front of him.

"As for Nathan, he's had almost nothing in terms of game time. It would have been difficult to think about playing Nathan in a really competitive match like a play-off semi-final.

"But this is an opportunity to get some minutes into his legs which will be good for us and good for Nathan. Hopefully he performs so well that he makes Frank pick him for Everton.

"I know Frank well and I've had a little conversation with him about Nathan but obviously Frank is in a situation where he is scrapping for points to stay in the Premier League.

"I'd like to think, if Nathan came into the team and hit the

levels we know he can hit, he'll maybe get a bit more game time for Everton between now and the end of the season."

Then there's the Ryans – Jack and Fraser – but shared first names are perhaps all they have in common right now.

Clarke can't wait to get one of them back after a prolonged injury. The other will have to wait, after not being quite as injured as he claimed when he pulled out of the last squad. In fact it could be a long way back from Newcastle for Ryan Fraser.

Clarke says: "I had a really good conversation with Ryan Fraser. He apologised for the way it turned out in November.

"I decided not to pick him for this camp but I've told him that his performances for Newcastle will determine whether he's selected for any ongoing squads. That's how we left that one.

"He said sorry so that's normally a sign that someone accepts that they didn't deal with the situation properly."

But when asked of a recall for Rangers linchpin Jack, Clarke could not have been more complimentary, saying: "I never really had any doubts about Ryan because of his character. I know what he's like and I obviously spoke to him a couple of times over his prolonged period out.

"He was an integral part of the team that qualified for Euro 2020. That he couldn't make it was disappointing for me but probably devastating for Ryan.

"So to come back and hit the ground running? Normally if someone is out for six months injured it takes a similar length of time before they get back to their best. Ryan was out for the best part of a year and he's come back at his normal level.

"That's credit to the work he did over his rehab period and the fact he has such a strong mental attitude that he can be such a key player for Rangers and hopefully for Scotland going forward."

Clarke tries to bring back Scots feelgood factor against bitter backdrop of tragedy

World of

THE SQUAD

GOALKEEPERS: Craig Gordon, Liam Kelly, David Marshall.

DEFENDERS: Jack Hendry, Grant Hanley, Aaron Hickey, Scott McKenna, Stephen O'Donnell, Nathan Patterson, Andy Robertson, Greg Taylor, Kieran Tierney.

MIDFIELDERS: Stuart Armstrong, Lewis Ferguson, Billy Gilmour, Ryan Jack, John McGinn, Callum McGregor, Kenny McLean, Scott McTominay.

ATTACKERS: Che Adams, Jacob Brown, Lyndon Dykes, Ryan Christie.

GAFFER FOCUSING SQUAD FOR FRIENDLIES



The general feeling is they want to get back together and see their mates

STEVE CLARKE WANTS TO SEE HIS PLAYERS BONDING AGAIN

GET THE FEELING BACK Clarke wants his stars to bond like they did when beating the Danes back in November



FIFA TALKS Noel Mooney

Wales FA: We were OK on Ukraine bye

BY ALAN MARSHALL

WALES were open to Ukraine being handed a bye to the 2022 World Cup when it was discussed by FIFA after the country's invasion by Russia.

Wales, Scotland and Austria are in the same play-off path as Ukraine, with the winners filling one of the final three European qualification places for Qatar.

Ukraine's visit to Hampden on March 24 has now been delayed until June with the Wales-Austria semi-final going ahead on the same night in Cardiff.

FIFA held talks with the four FAs over play-off rescheduling – and its impact on their Nations League fixtures in June.

Wales FA's chief Noel Mooney said: "It was a Welsh perspective if it could be accommodated it could be a really good thing to do."

"It's something as a human being you would say, 'OK if they're not ready to play in June should they be given a bye'.

"There was some loose discussion around it, saying could you get an extra space for Ukraine because of the horrendous time they are going through.

"But it would mean an extra team in the World Cup as there's three teams left – ourselves, Scotland and Austria.

"We would have been comfortable with giving Ukraine a bye with the other three fighting it out among ourselves [for one place].

"The feeling was a 28-day tournament wouldn't facilitate it.

"It's a possibility [Ukraine won't play] but no-one wants to see that."

THE IRON MAN IN THE MASK

PAGES 48&49

difference



Record Sport

WEDNESDAY, MARCH 16, 2022

FANFARE
O'Riley
will be
fired up
by crowd



50/50 HIT

Matt can't wait for hostile Hampden

MATT O'RILEY reckons a hostile Hampden will be even more wild than spine-tingling Celtic Park when the Old Firm collide in next month's Scottish

BY MICHAEL GANNON

Cup semi showdown. The playmaker was lost for words after the 3-0 derby demolition
TURN TO PAGE 48

CHELTENHAM 2022

SCOTLAND RIDING HIGH

» Alexander's Honeysuckle is star of the day

» Lucinda's Rambler the Ultima hero

» Stattler seals glory day in last

» King's Edwardstone batters field

SWEET SUCCESS
Rachael Blackmore celebrates on Honeysuckle



12-PAGE PUNTER INSIDE

PLUS

FREE £2 SHOP BET

DON'T HIT MY SCOTS FOR 6

BY KEITH JACKSON

STEVE CLARKE last night pleaded with world football's governing bodies not to punish Scotland's players for Russia's atrocities by hitting them with a six-game fixture pile-up in June.

Clarke named a squad yesterday for two friendly matches which had to be arranged at the 11th hour after Vladimir Putin plunged the world into crisis by ordering his war machine into action.

Scotland's semi-final play-off with Ukraine has also been rescheduled for June, with the

TURN TO PAGE 50

PASSIONATE PLEA
Clarke is still hopeful

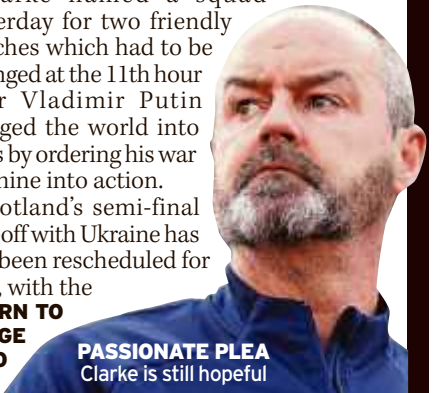

Steve pleads with UEFA over fixture pile-up

NEWSPAPERS SUPPORT RECYCLING
The recycled paper content of UK newspapers in 2018 was 68.2%

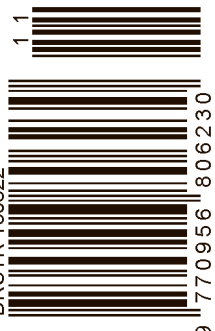

FREE £5 BET

ON ANY RACE

Today at Cheltenham

taketimetothink.co.uk

TAKE TIME TO THINK

BeGambleAware.org

ONLINE EXCLUSIVE. Available to new & existing customers. Max one £5 free bet per customer. Free Bet can be used on any race at Cheltenham on Wednesday 16th March. New customers must deposit a minimum £5, and existing customers must have previously deposited, using a debit card, Apple Pay or PaySafe to avail the offer. Free bet will be available from Tuesday 12pm 15th March. New customers registering from 14th March using PayPal to deposit are not eligible for the promo. If you have been excluded from promotions by Paddy Power, you won't receive the free bet. Full T&Cs available at paddypower.com



EXTRA PUZZLES

Logic

Using the grid below, can you work out where each delivery should go? **Solutions at the end**

Andy was the caretaker at an office block in an up-market part of town. He was on first-name terms with many of the occupants and knew each of their professions.

It was his practice to accept deliveries on their behalf throughout the day and hand them over as they passed by his desk in the foyer. On one particular day he decided that his new colleague, Adam, should familiarise himself with the building - so he left him a note of the five outstanding deliveries while he went for lunch.

He asked Adam to ensure the deliveries went to the correct occupants. Adam read the note and was able to solve the problem in minutes - even though the writing was smudged in places. Can you?

*The parcel of books is expected by the Solicitor, and the urgent letter should be handed to A—the A—below the 8th floor.
The case of wine goes to the writer who works on a floor above the accountant, and the dry cleaning belongs to Sheila, who works on the floor below Sam.
Remember, Sheila is not the accountant, and Sam doesn't take magazines. Fred's office is on the same floor as the architect, and did you know that Alice is teetotal?*

	Fred	Sam	Alice	Sheila	Archie	Magazine	Parcel of books	Case of wine	Urgent letter	Dry cleaning	2nd Floor	3rd Floor	5th Floor (a)	5th Floor (b)	8th Floor
Writer															
Architect															
Solicitor															
Accountant															
Optician															
2nd Floor															
3rd Floor															
5th Floor (a)															
5th Floor (b)															
8th Floor															
Magazine															
Parcel of books															
Case of wine															
Urgent letter															
Dry cleaning															



Word Spiral

Starting from 1, fill in the grid clockwise with four-letter words. The last letter of each word becomes the first letter of the next to reveal a hidden word. **Solutions at the end**

1			2		3
	9		10		
	14		15		
8				11	4
		16			
	13		12		
7		6			5

- 1 Male monarch
- 2 Increase in size
- 3 Broad
- 4 Cupid
- 5 Go by boat
- 6 Touch down
- 7 Terrible fate
- 8 Humble
- 9 Flying toy
- 10 Heroic
- 11 Coffee bar
- 12 Finishes
- 13 Injure with a knife
- 14 Past tense of blow
- 15 Delicate strand
- 16 Serve a drink

Keyword clue: Boy's name

Battleships

Find where the fleet of ships shown are hidden in the grid. The numbers to the right of and below the grid indicate how many of the squares in that row are filled in with ships or parts of ships. The ships do not touch each other, even diagonally. Some squares have been filled in to start you off. **Solutions at the end**

	1	2	3	4	5	6	7	8	9	10	
A					●						1
B		●									2
C											1
D										■	2
E											2
F							●				3
G											1
H			●								3
I										●	1
J											4
	3	1	1	4	2	1	2	3	2	1	

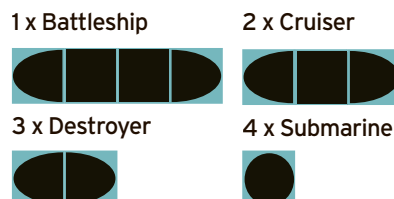

Codeword

In this completed crossword puzzle, each letter has been replaced with a number. Three letters have been given to start you off, so write these letters wherever their numbers appear in the grid. The completed grid will include all letters of the alphabet. Remember, none of the answers are proper nouns. **Solutions at the end**

	2		16		25		18		21		
9	19	7	3		19	13	18	15	7	6	10
					A	L	B				
	26		4	9	9			19		4	22
	7		4		6	15	1	6		17	23
21	2	7	26	17		20					10
	19			7	20	6	15	3	12	15	23
	8			2		7		19			24
21	15	5	10	15	21	6	15	3			7
22							13		15	3	10
4		26		15	14	15	20		24		26
3	11	15		17			7	14	11		10
25		21	2	7	7	20	16		26	7	20
		24		23			24		15		2

1	2	3	4	5	6	7	8	9	10	11	12	13	L
14	15	16	17	18	19	20	21	22	23	24	25	26	

A
B
C
D
E
F
G
H
I
J
K
L
M
N
O
P
Q
R
S
T
U
V
W
X
Y
Z

EXTRA PUZZLES

Big Picture

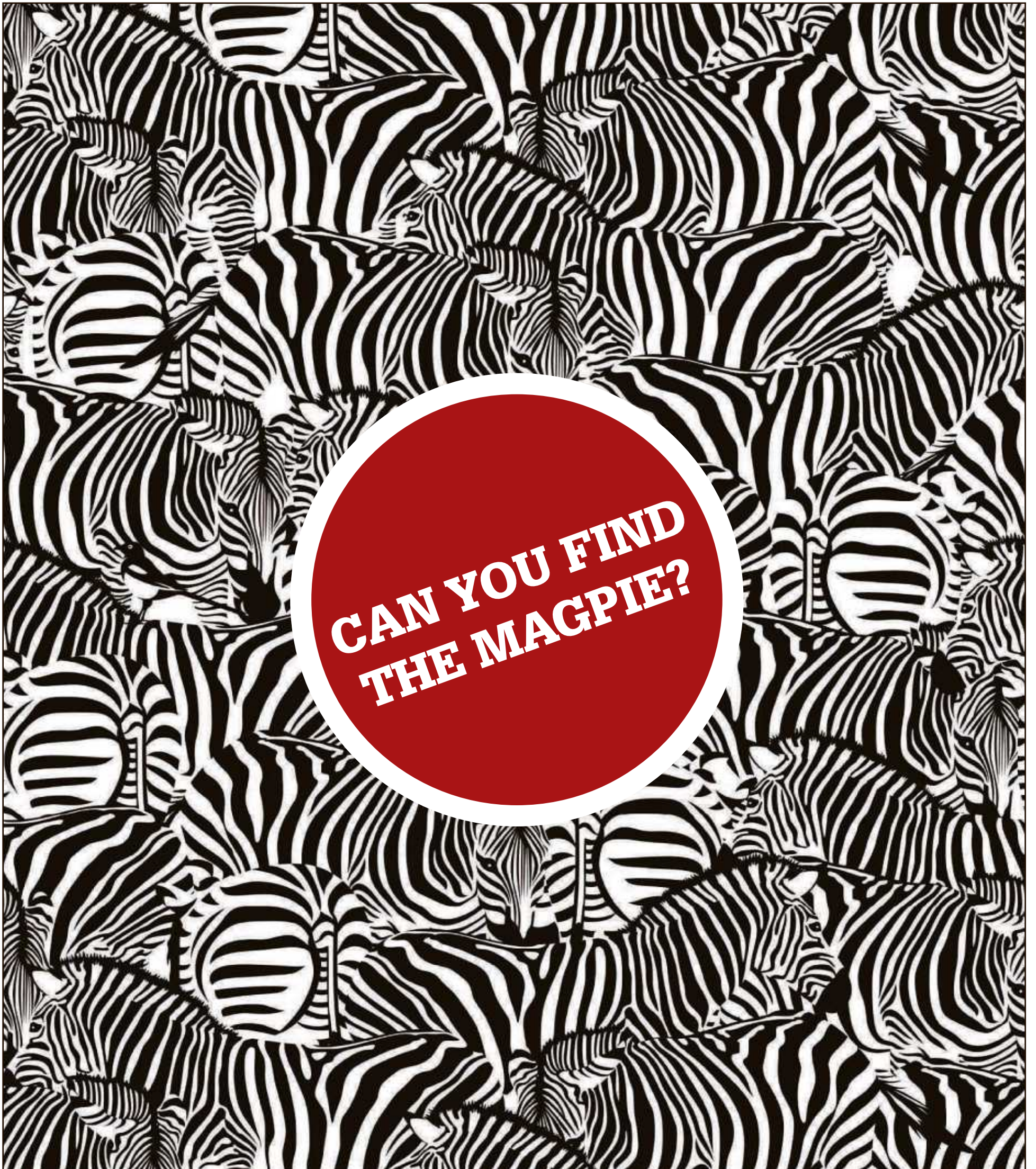

Enter Vowel

Each clue is the answer word with the vowels removed. For example, a clue PL (4) might lead to Plea, Pile, Peal, Opal etc but not Loop or Lope. You'll have to work out which option fits with its neighbours to complete the grid.
Solutions at the end

1	2	3	4	5	6	7
8			9			
10				11		
	12	13		14		
15						16
17			18	19	20	
	21				22	
23			24			

Across

- 1 RPM (8)
- 6 TH (4)
- 8 CHN (4)
- 9 GNBL (7)
- 10 LRV (5)
- 11 TTN (6)
- 12 THRHLF (5,4)
- 17 LNR (6)
- 19 CTD (5)
- 21 BRDLS (7)
- 22 GGS (4)
- 23 GG (4)
- 24 CTTN (8)

Down

- 2 PHLL (6)
- 3 WNR (5)
- 4 MTT (7)
- 5 MN (5)
- 6 RBTL (7)
- 7 TPN (6)
- 13 TRNG (3,4)
- 14 HDST (7)
- 15 RBG (6)
- 16 DG (6)
- 18 RLC (5)
- 20 TRT (5)

Double Jigword

Arrange these crossword fragments to create two completed symmetrical crosswords in the grids below.
Solutions at the end

K E W	L U	O	T	G	B E T
A	I N	I N C	A C H	T H E	U E
T T E	S H A	S	N A	T	L O D
A	N T	S	A L L	H A L	B S
I T O	S A U	E K	A	O D	O G N
R	E T	T	R U L	G S	B A
R O T	O	A R M	E F	O O P	S C
P	R U S	G I	E P I	C	S K
G I N	S	R E D	E	H I D	E R

Su-doku Corner

The rules for Su-doku couldn't be easier. All you have to do is fill the empty squares so that each row, column and 3x3 block contains all the numbers 1 to 9.
Solutions at the end

DIFFICULTY EASY

		9		7	6	1	5
6			2		8		
		8		9	7	2	4
	9		2			6	1
3		5					7
7	4		8			5	
		3			5		
	8		6	2			3
4	6	1	9		2		8

DIFFICULTY MEDIUM

	5		9	8		3	
		8			7		
			7	6		2	5
5		9		2		1	7
	8			9		6	
2		1		8		5	9
			8	2			
8		6			9		
	4		3	1		7	

DIFFICULTY HARD

1	7	4					
9			7			2	
5			3				1
	3	9		2			
			8		5		
				9		1	7
	6				3		1
		8			1		6
						4	5
							8

Solutions at the end

EXTRA PUZZLES

Big X Su-doku

The rules for Big X Su-doku vary only slightly from the standard su-doku rules. The 9x9 su-doku at the centre of the X shares four of its 3x3 boxes with those of the outer su-doku. None of the 9x9 su-dokus can be solved individually, you must cross-reference between the intersecting grids. **Solutions at the end**

			1	8	3				9	5	1			2					
		6			2	7									5	6	8		
	8		5	2	7						4	3		7					
		5				1	4	8					8		3		1		
6		8		7	3				8	9					4				
		1		4		3	7		2			7	1						
1	5		7		9						5		4				9	5	
			2		4				4		6							8	4
9	2		6								3		9		4	2	8		
					2						4		8		9				
							9				7		2						
					5	9	7												
7				8	6				8	6								4	2
2						1		9						6		2		5	
6		3		5					3	1					9		7		1
		8			5							3	6		9		5		
			9		1									1	7			6	
1		2												5	9			8	
	5		8	1		6								8		1			7
	2					8	3					3	1	7		6			
	3		6				9										1		6

Honeycomb

All the solutions read clockwise around their numbers. The solution to clue number 1 starts from the given letter.

- Dad
- Aim
- Tie up
- Treat
- Feature
- Be present
- Approached
- Haphazard
- Reason
- Dupe
- Noon
- Stick

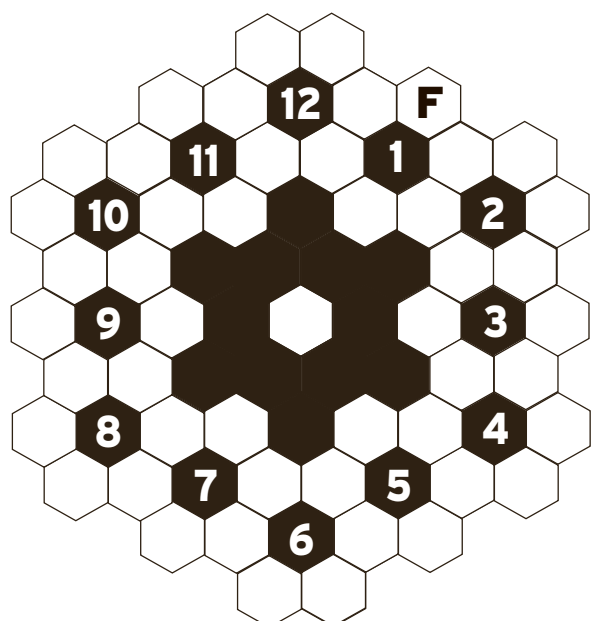

Solutions at the end

Word wheel

You have 10 mins to find as many words as possible using the letters in the wheel. Each must use the hub letter and at least 3 others. Letters may be used only once. You cannot use plurals, foreign words or proper nouns. There is at least one 9-letter word to be found.

Solutions at the end
How you rate:
25 words, average; 35 words, good; 45 words, very good; 60 or more, excellent.

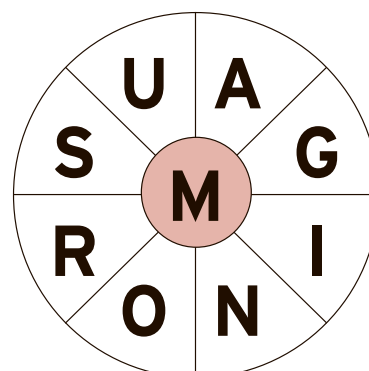

General knowledge quiz

ART & LITERATURE

- Who wrote Lady Chatterley's Lover?
- Which British novelist and dramatist wrote An Inspector Calls?
- Which German novelist wrote The Tin Drum?
- Which surrealist painter wrote the autobiographical Diary of a Genius?
- Which poet published his Poems, Chiefly in the Scottish Dialect in 1786?
- Which British novelist wrote A Town Like Alice?

GEOGRAPHY

- Which American barrier island was known as Cape Kennedy from 1963 to 1973?
- What is the capital of Panama?
- In which state of the USA is the city of Reno, known for its casinos?
- The Nore is a sandbank at the mouth of which UK river?
- In which continent are the Altai Mountains?
- In which country is the resort of Acapulco?

NATURE

- Which birds are famous for the sound made by their wings and being able to fly backwards?
- Of which fruit are the honeydew and cantaloupe varieties?
- How many legs does a scorpion have?
- What sort of creature is a salamander?
- Which plant's leaves are the traditional antidote to nettle stings?
- What sort of creature is an oystercatcher?

SPORT & LEISURE

- Which British Grand Prix driver was world champion in 1969, 1971 and 1973?
- At what sort of spectator sport would one find matadors and picadors?
- Which county cricket team's ground is situated at Hove?
- Which stadium was the site of the 1948 Olympics?
- With which sport was Sir Stanley Matthews associated?
- Which two countries compete for cricket's Ashes?

POT LUCK

- Who is the patron saint of Ireland?
- Which fortune-telling aid consists of the minor arcana and the major arcana?
- What is the standard currency of Japan?
- What are the two main political parties in the USA?
- How is the oldest known explosive, black powder, better known?
- Which environmentally friendly cosmetics group was founded by Anita Roddick?

Answers at the end

Pathfinder

Beginning with the top highlighted letter, follow a continuous path of words associated with the given subject. The trail goes through each letter once, twisting up, down and sideways, but never diagonally.

Solutions at the end

ANNE HATHAWAY FILMS

T	A	P	A	O	N	I	O	L	C	O	N	G	E	L
H	D	A	S	I	R	C	H	A	E	M	I	J	H	G
E	D	R	S	E	S	E	N	S	B	Y	N	A	C	E
V	E	P	S	N	G	S	I	L	E	B	E	R	A	T
I	L	W	R	R	E	I	C	K	R	R	A	N	I	T
L	T	E	A	S	B	R	T	H	I	E	M	G	E	A
E	R	S	T	E	R	I	I	G	O	D	L	O	V	N
S	A	M	S	G	E	D	N	K	N	A	Y	T	O	D
M	E	R	R	A	W	A	R	K	E	D	E	H	C	K
I	S	A	B	H	E	D	S	E	G	U	R	B	A	M
E	K	N	L	T	Y	A	D	N	S	R	D	E	U	O
D	A	I	E	S	E	N	T	I	T	H	O	K	N	T
I	L	W	D	H	L	A	V	R	P	E	R	E	I	A
C	N	W	O	O	R	L	D	I	E	S	B	S	R	I
E	I	O	N	D	E	A	N	N	C	S	D	I	A	N

Niner

Each number from 1 to 9 represents a different letter. Solve the clues and insert the letters in the appropriate squares to discover a word which uses all nine letters.

1 43518 gives an entertainer
45674 gives an entertainer
9322 gives entertainment

1	2	3	4	5	6	7	8	9
---	---	---	---	---	---	---	---	---

2 978 gives a drink
1564 gives a fish
35892 gives a fruit

1	2	3	4	5	6	7	8	9
---	---	---	---	---	---	---	---	---

Triangle

Draw 3 straight lines to make 5 triangles. Lines must be drawn from dot to dot, either passing through one dot or none at all. Valid triangles must not contain lines running through them, every line segment must form part of a triangle.

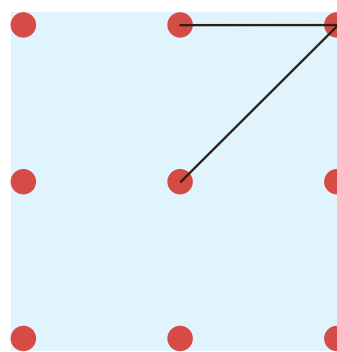

Loop

Draw a continuous loop in the grid so that the number in each circle corresponds to the number of adjacent squares containing turns in the loop. Part of the loop has been drawn to get you started. **Solutions at the end**

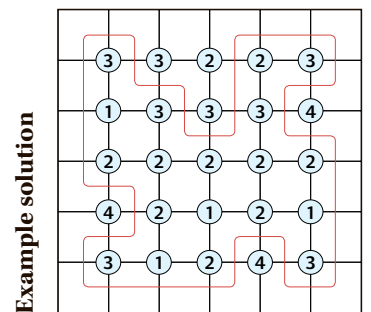
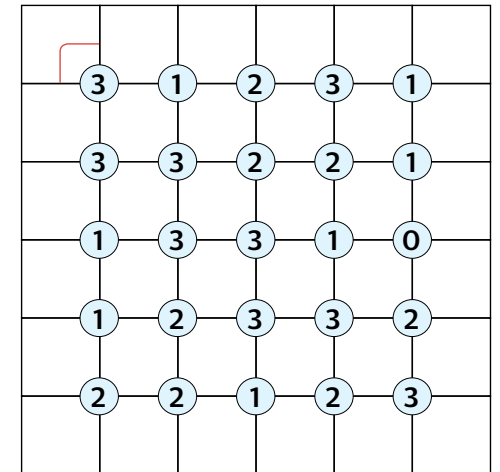

Arrow Word

The arrows show the direction in which the answer to each clue should be placed. **Solutions at the end**

Mineral spring	Scotland Close friend	Proverbs	Net	Insect	Moves a train to a siding	Large number or crowd	Shortly	Pool Leather worker	Burden
		Hatchet		Fatigue					
		Bird							
_ Jones, TV host			Knight's title		Jumpy (2,4)	Truckful			Oust
Flaw			Card suit						
				Tedious					
				City on the Po					
Bother	Drop heavily			Hue		Tavern		Row	Brink
	Eat less			Behind time					
		Military gestures				Owned	Besides		
							Agent		
Squid's fluid			Risked			Done in haste			
Garland									
		Bigfoot			Forest clearing			Horse	
Levy			Perceive			Use up			

EXTRA PUZZLES

Spot the difference

Can you find six differences between the two pictures below?
Solutions at the end

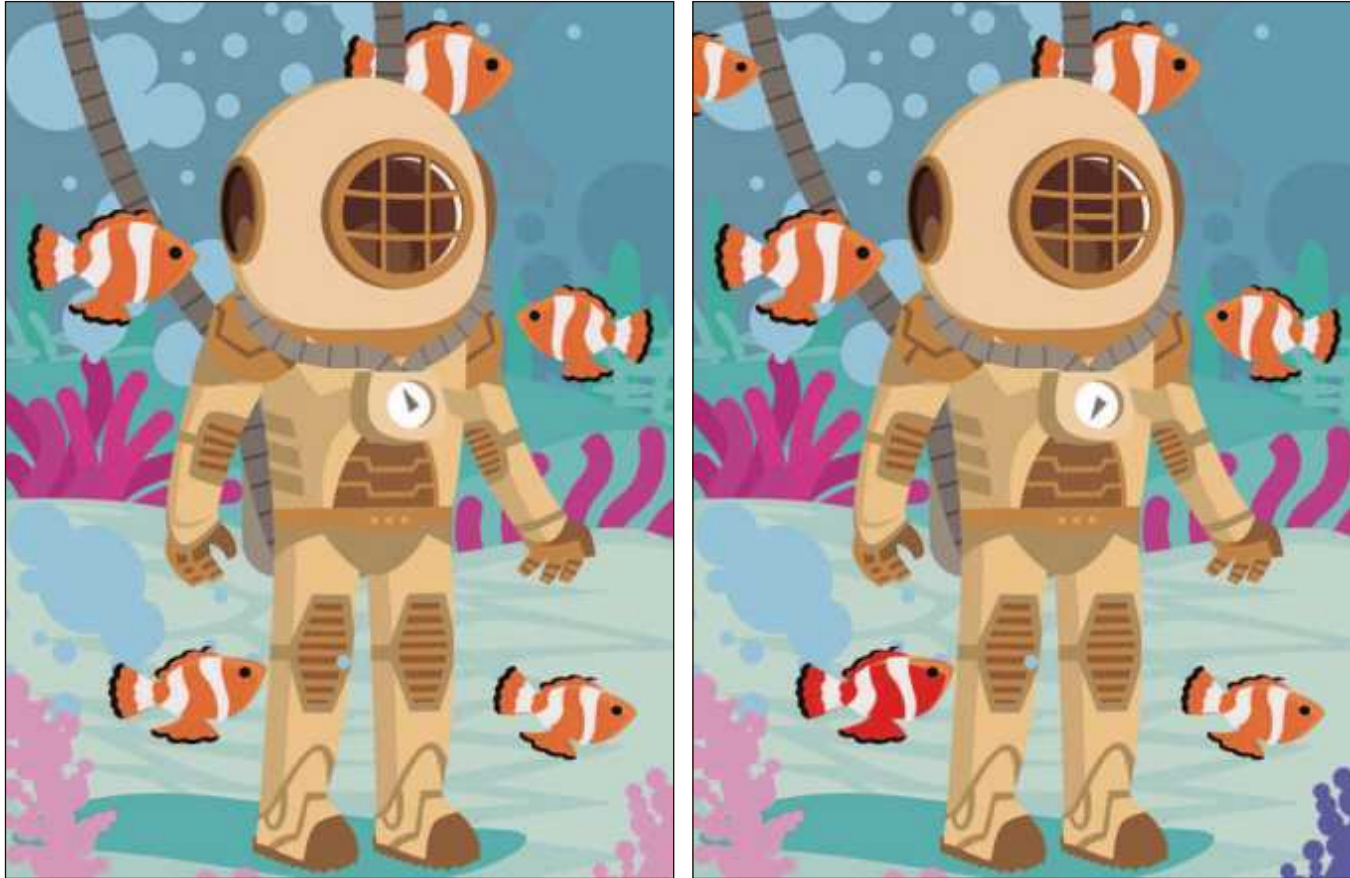

Clockword

The solutions from 1 to 12 are all six-letter words ending with the letter Y in the centre. Moving clockwise from 1, the letters in the outer ring will spell out the name of a celebrity club owner. **Solutions at the end**

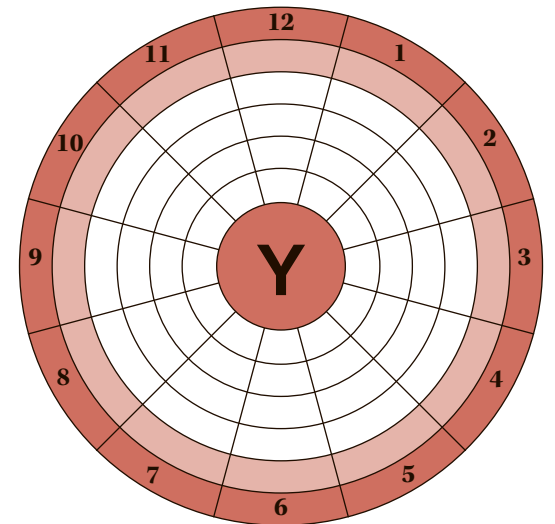

- | | |
|----------------|--------------|
| 1 Madness | 7 Stuck-up |
| 2 Impolitely | 8 Miserable |
| 3 Beehive | 9 Gypsy |
| 4 Specifically | 10 Sharpness |
| 5 Impertinent | 11 Whim |
| 6 Inhabit | 12 Take on |

Mirrorgram

Solve our ten-letter anagram. **Solutions at the end**

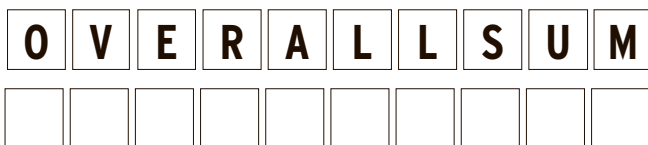

Anagram crossword

Fill in the grid using anagrams of the listed words. There may be more than one option for each word.
Solutions at the end

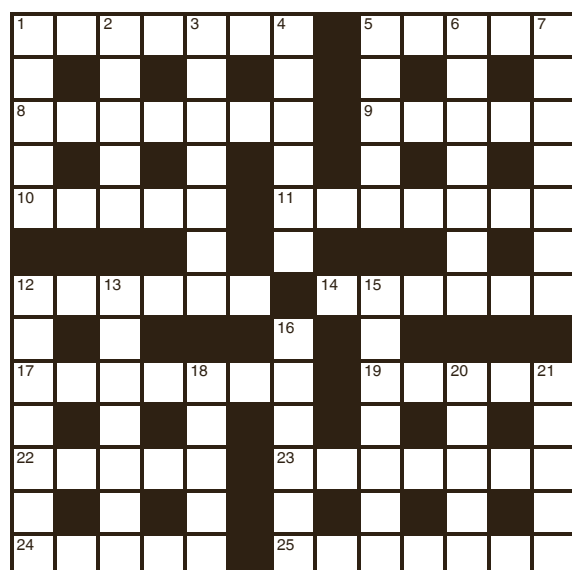

- Across**
- 1 LAMAISM
 - 5 RUNTS
 - 8 REDDENS
 - 9 TRIBE
 - 10 I CAN'T
 - 11 LEAVENS
 - 12 COILED
 - 14 ETHICS
 - 17 SINATRA
 - 19 DIRAC
 - 22 PILAR
 - 23 SPIED ME
 - 24 TONNE
 - 25 HE CREWS
- Down**
- 1 AIMED
 - 2 LATER
 - 3 DECLAIM
 - 4 CANTLE
 - 5 ABUTS
 - 6 HECTARE
 - 7 HE RISKS
 - 12 I DAREN'T
 - 13 ARCHING
 - 15 PASTIER
 - 16 CAIMAN
 - 18 I LENT
 - 20 DIRGE
 - 21 STUDS

Fill In

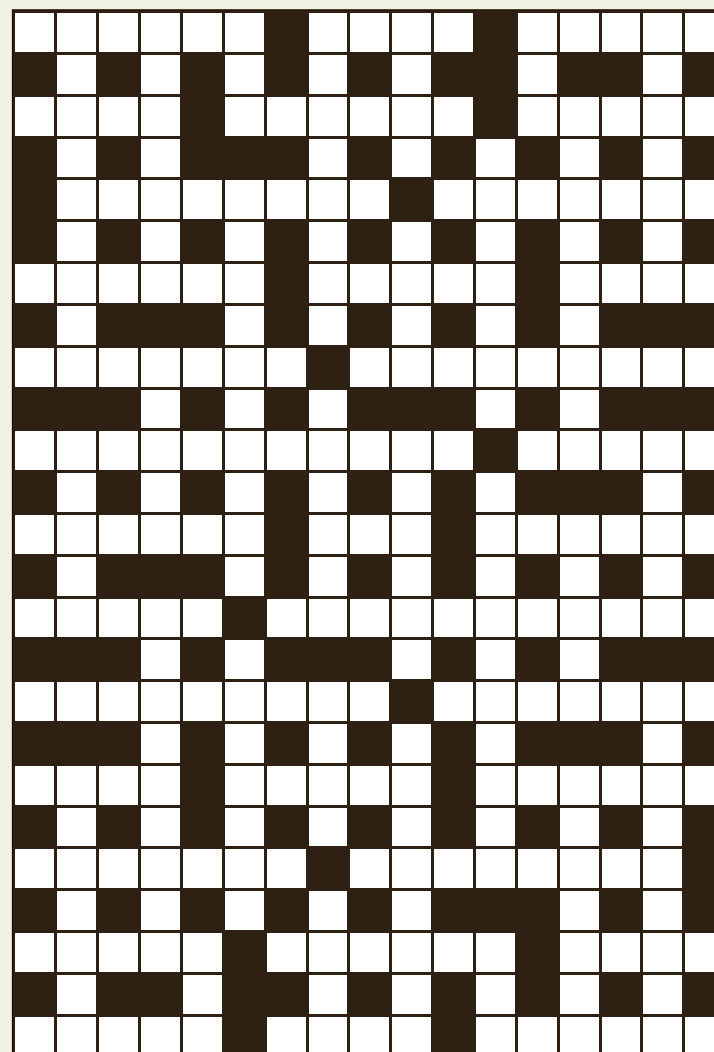

There are no clues to this word puzzle other than the number of squares in the grid and the length of the words or phrases. Can you place all the words in the grid?
Solutions at the end

- | | |
|------------------|-------------------|
| 3 LETTERS | OWLISH |
| BUG | PORTER |
| GAP | TANDEM |
| NIT | TARTAN |
| NOD | |
| TIC | 7 LETTERS |
| | AEROSOL |
| 4 LETTERS | BLEMISH |
| AREA | FURNACE |
| BASK | HAMPERS |
| CHIC | LIAISON |
| OATH | MAGENTA |
| SLAM | MANTLED |
| SMOG | PAINTER |
| STYE | REALISM |
| SUNK | TRAINER |
| TASK | |
| YOGA | 8 LETTERS |
| | CHIPMUNK |
| 5 LETTERS | ECLECTIC |
| ASPEN | SEASCAPE |
| BLAND | SORENESS |
| BUSHY | |
| GNOME | 9 LETTERS |
| HERON | ARTICHOKE |
| LATTE | CASSEROLE |
| REUSE | MENOPAUSE |
| SNORE | NINETIETH |
| TACIT | PARTNERED |
| TUNIC | STOCKPILE |
| USAGE | |
| WHITE | 10 LETTERS |
| 6 LETTERS | METICULOUS |
| BAGELS | MOROSENESS |
| COTON | |
| ETCHER | 11 LETTERS |
| ETHICS | BUTTONHOLED |
| GASBAG | INFERIORITY |
| GOPHER | |

Mindbenders

Can you tackle this tricky set of logical posers, fiendish word games and mathematical mysteries?

Solutions at the end

1 Some friends play a game in which they guess who holds the most coins in their hand. 'I guessed the person Tina guessed last time, and Tony guessed the person who guessed me last time', said Troy. 'The person who guessed Tess last time guessed me this time', said Tony. No one guessed themselves or the same person twice. If both rounds so far have been four-way ties, who did each person guess initially?

2 Which two words meaning 'record' and 'suffer defeat' combine into one meaning 'reveal'?

3 Find the ball sports in these anagrams: a) Burning You, b) Lose Cars, c) Nettle Basin.

4 The film Blade Runner was released in 1982 and set in 2019. Its sequel, Blade Runner 2049, was released in 2017 and set in 2049. If an

unlimited number of further films are produced in the series, and assuming that the interval between release dates and the interval between the setting of each film remains constant, which film will be the first to take place in the past?

5 It's 4pm at a sunny Spanish resort, and the holidaying Winter family have just come back indoors after a spot of sunbathing. Rob was out for twenty-seven minutes less than Samantha, who was out for five minutes more than Lance, who sunbathed for half as long as Beverley. If the average time each spent in the sun was fifty-two minutes, what time did Beverley go out?

Gogen

Insert letters to form the listed words, moving between adjacent cells horizontally, vertically or diagonally in any direction. Insert all the remaining letters of the alphabet (except Z) in the grid so all the listed words are spelt out in this way.

Solutions at the end

1

F		N		Q
V		T		B
R		M		J

AB CDEFGHIJKL MNOPQR STU VWXY

BOXER
COY
DIG
FILE
HEMP
JOCUND
MOCK
SQUAT
WAIVE

2

X		T		F
B		R		V
Y		J		S

AB CDEFGHIJKL MNOPQR STU VWXY

CORN
CRIMP
DIMLY
EQUABLY
JAY
MIX
PITCHFORK
SNUGLY
TOKES
WOVEN

Jigsaw su-doku

	2	7				5
			4		1	
			8	6		
6			5			9
2						8
9			7			1
		9	4			
			6		2	
	5	8				1

Fill in the rows, columns and boxes with the numbers 1 to 9 without the same number appearing twice in any row, column or box.

Solutions at the end

Killer su-doku

22			17		13		11	
	5		17			14	10	
11	20			4				5
	15		10	11		12		
7				18	10		15	
		10				13		
15	9		4		11		14	
	13	12	21		8		18	
						10		

Killer Su-doku is based on the traditional grid and every column, every row and every 3x3 box must contain the digits 1 to 9. But the dotted squares must be filled with numbers that add up to that in the left corner.

Solutions at the end

Circlegram

Replace the question mark with a letter so that the letters within each circle can be arranged to form words, names or terms on a common theme. What are the three words, and the letter represented by the question mark?

Solutions at the end

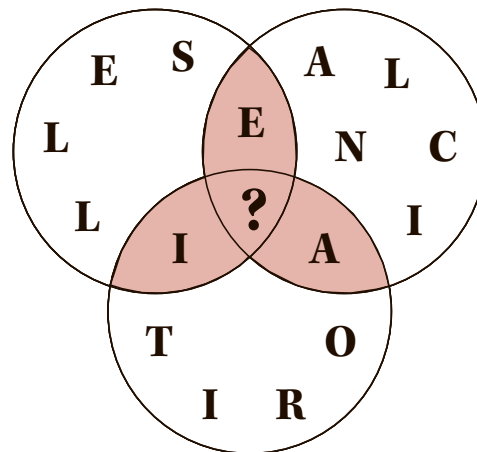

Kakuro

		16	30				4	6
	12				4	29		
	8	4		10				
36				12				
10					5		15	
					6			4
	7			10				
				8				
	9	11						
30					8			
3					3			

Fill in the white squares with the numbers 1 to 9. Each horizontal block of squares must add up to the number in the shaded square to its left, and each vertical block must add up to the number in the shaded square above it. No number may be used more than once in any one block.

Solutions at the end

Futoshiki

4		<			
>			>		
	<			>	
	>	<			<

Insert the numbers one to five in each row and each column, making sure that no number is repeated. The only symbols to guide you are the "greater than" (>) and "less than" (<) signs.

Solutions at the end

Split Decision

Cross out one of the two letters in each divided square to reveal a completed crossword grid.

S	N	U	M	L
T	H	S	B	B
W		L		E
L		N		A
I	G	D	S	A
A	N	I	I	T
M		P		P
G		E		N
S	T	R	T	T
E	O	S	M	S



Scotland's best racing guide by a distance

Daily Record Wednesday, March 16, 2022

The Punter

IN ASSOCIATION WITH 

SCOT A START Tartan winners Blackmore on Honeysuckle, main pic, Fox and Russell with Corach Rambler, bottom, and Edwardstone



GARRY OWEN'S DAY TWO VERDICT

There's no such thing as a bad Presse



McCHELTENHAM

Scotland rule the roost on day one of Festival - page 7

Superstar's set to hit L'Homme run for punters

BY GARRY OWEN

L'HOMME PRESSE (2.10) looks red-hot in the Brown Advisory Chase on day two of the Cheltenham Festival.

Venetia Williams' charge has barely put a foot wrong during his amazing first season over fences. The gelding opened **TURN TO PUNTER 6**

NEW CUSTOMER OFFER AT CHELTENHAM...

BET £10 **GET £50**

SIGN UP USING PROMO CODE **PRESS50**



it's who you play with /

William **HILL**



TAKE TIME TO THINK

taketimetothink.co.uk

18+

BeGambleAware.org

New online customers using Promo code PRESS50 only. Min £10/€10 stake, min odds 1/2, free bets paid as 5 x £10/€10, free bets credited after settlement of first qualifying bet, free bets will expire 30 days after the qualifying bet is placed, payment method/player/country restrictions apply. William Hill rules apply. Over 18s only. For advice & information visit begambleaware.org. National Gambling Helpline 0808 8020 133.



POT OF GOLD

MELISSA JONES' Placepot fancies

GRAND HOPE Thyme White



Thyme right for Bryony to seal the deal

1.30 SIR GERHARD is a novice to note as the Ballymore kicks off day two at Cheltenham.

Willie Mullins' star engaged the turbo at Leopardstown despite some jumping errors. He still won well and will be hard to beat here.

SELECTION: SIR GERHARD

2.10 L'HOMME PRESSE will be hard to keep out of the frame in the Brown Advisory.

Thriving over fences, he has experience of this track and is capable of better.

Charlie Deutsch is at the top of his game and he will deliver the selection at the right time. Stamina-laden Beacon Edge, last season's Stayers' Hurdle fourth, is worth adding too.

SELECTION: L'HOMME PRESSE, BEACON EDGE

2.50 SAINT FELICIEN deserves plenty of respect in the Coral Cup as this Irish raider a workable handicap debut mark.

Unexpected Party scored easily at Ascot and a 12lb rise should not prevent another big race.

SELECTION: SAINT FELICIEN, UNEXPECTED PARTY

3.30 SUPERSTAR SHISHKIN has two Festival wins to his name and can make it three in the Champion Chase.

He holds Energumene on Ascot form, when that rival was ridden perfectly by Paul Townend. By contrast, Shishkin had a couple of blips and can do even better at his favourite track.

SELECTION: SHISHKIN

4.10 All eyes will be on TIGER ROLL as he chases a staggering six Festival successes.

He loves the venue, so don't read too much into several below-par efforts this season.

He will bounce off the spring ground and is fancied to lead home stablemate Delta Work.

SELECTION: TIGER ROLL

4.50 THYME WHITE won with plenty in hand before being put away for the Grand Annual. Paul Nicholls rates his chances and Bryony Frost (above) gets on well with him.

Buddy Rich, also coming here after an absence, is high on the shortlist for shrewd connections who took this in 2020.

SELECTION: THYME WHITE, BUDDY RICH
PLACEPOT PLAN: Eight lines at 50p = £4



NEWSBOY'S 1-2-3
1 SIR GERHARD
2 STAGE STAR
3 I AM MAXIMUS

SIR GERHARD is sure to go off at prohibitive odds - but it is hard to see past him.

Successful from stablemate Kilcruit in the Champion Bumper 12 months ago, the Willie Mullins-trained son of Jeremy finished third to the same horse at Punchestown, but has been imperious in two attempts over hurdles this winter.

Sir Gerhard was sent off the 2-9 favourite for a maiden hurdle at Leopardstown on Boxing Day and wasn't extended as he won by eight lengths. Mullins then returned the seven-year-old to Foxrock for the Dublin Racing Festival's Grade 1 two-mile novice hurdle, and Paul Townend's partner overcame some scruffy jumping to come home six lengths to the good of Three Stripe Life.

The step up to two miles is unlikely to stretch my



HARD YARDS Sir Gerhard has already won at Prestbury Park

selection's stamina and, with the extra yardage an aid to ironing the creases in his hurdling, Sir Gerhard - running here in preference to yesterday's Supreme Novices' Hurdle - is expected to remain unbeaten over obstacles. Stage Star is already a

high achiever in the hands of Paul Nicholls - he gained an emphatic triumph in the top-level Challow Hurdle at Newbury on his most recent start - and the Ditcheat hope is feared most, ahead of I Am Maximus and Journey With Me.

TODAY'S ABC GUIDE TO FOUR UK MEETINGS

Table with 2 columns: Race Name and Time. Races include A Wave Of The Sea, Abingworth, Ace Time, Alloy Senor, Ain't No Sunshine, Alaskan Wind, Alpha Des Obeaux, Amarillo Sky, American Mike, Andy Dufresne, Anightinlambourne, Arousing, Artemision, Arwaag, Ashdale Bob, Atrafan, Au Jus, Author's Dream, Authorised Speed, Autonomy, Back On The Lash, Backinforgrory, Ballaquane, Beacon Edge, Before Midnight, Bella Beau, Bobby On The Beat, Bolt N Brown, Bomb Squad, Brahma Bull, Brains, Bravemansgame, Broken Rifle, Buddy Rich, Buxted Too, Call Me Harry, Call Me Lord, Camprond, Capodanno, Capuccimix.

Table with 2 columns: Race Name and Time. Races include Caracristi, Castle Keep, Catlow, Chacun Pour Soi, Champ Is Real, Champagne Gold, Charming Getaway, Chase The Dollar, Christopher Wood, Chronos, Cillians Charm, Cliffs Of Fury, Commander Of Fleet, Count Otto, Daily Tiger, Dancing On My Own, Danita, Dans Le Vent, Darcys Hill, Daryia, Deciduous, Definitive Force, Delta Work, Dembe, Diderot, Diesel D'Allier, Doireann, Double Dare You, Dragons Will Rise, Drop The Anchor, Dug A Win, Dwyart, Easyfran, Easysland, Editeur Du Gite, Eilean Dubh, El Bello, Elixir De Nutz, Elkstone, Embittered, Encouraged, Energumene, Enough Already, Envoi Allen.

Table with 2 columns: Race Name and Time. Races include Esperti, Exit Poll, Extraordinary Man, Facile Vega, Fair Frontiers, Fantasy Believer, Farouk D'Alene, Fastorlow, Fircombe Hall, Fist Pumping Time, Flyin' High, Follow Your Heart, For Fitz Sake, For Pleasure, Frero Banbou, Gioryella, Godeit, Gold Belt, Good Humor, Gosny Gold, Got No Dollars, Gowel Road, Graignes, Grand Roi, Gullin, Gumball, Haas Boy, Handel, Hang In There, Harry's Hottie, Hasankey, Haxo, Haykal.

Table with 2 columns: Race Name and Time. Races include Headingley, Hellavaheart, Hello Sunshine, Hemlock, Hesperantha, High Born Eagle, High Wells, Ho! An Beach, Honest Oscar, Houlanbatordechais, Hunky, I Am Maximus, I Know How, Idoapologise, Il Ridoto, Imagemaker, Imperial Command, Indian Pearl, Indigo Breeze, Inferno Sacree, Infiniti, Ingennio, Inner Light, Jalea Moon, James's Gate, Johnny Reb, Joly Maker, Jomont, Journey With Me, Joyeux Machin, Jungle Inthebungle, Just In Time, Kingston King, L'Homme Presse, Lanfear, Lanny, Lary Night, Leopolds Rock, Leskinfere, Liamarty Dreams, Little Boy Blue, Lockdown, Lopes Dancer.

Table with 2 columns: Race Name and Time. Races include Lord Sparky, Lost Of Love, Madmansgame, Main Target, Mars Harper, Maykir, Maze Runner, McFabulous, Midnight Maestro, Military Two Step, Millies Mite, Million Reasons, Miss Calculation, Miss Delighted, Miss Malarky, Mitchouka, Mohareb, Motaraja, Mr McCall, Music Drive, Nubeymax, Nube Negra, Ocean Of Mercy, On The River, Our Jester, Outsmart, Overtougeorge, Oxygen Thief, Pakie's Dream, Pallas Dancer, Paolo Panini, Parisian Blue, Party Island, Pembroke, Plan Of Attack, Planxy, Lary Night, Leopolds Rock, Leskinfere, Liamarty Dreams, Little Boy Blue, Lockdown, Lopes Dancer.

Table with 2 columns: Race Name and Time. Races include Prince Of Abington, Proclaimar, Propelled, Puerto De Vega, Put The Kettle On, Queen Of The Court, Rathmacknee, Red Allure, Red Royalist, Redemption Day, Reine Fee, Resumption, Rio Silva, Rizzardo, Rockade, Rosy Redrum, Safe Passage, Saint Felicien, Sainit Peter, Sailgo Bay, Salvator Mundi, Saoria, Sawpit Sienna, Sayfiyowill, Scarface, Sea Grey, Seabank Bistro, Seebat Handshelkh, Seventh Kingdom, Shady Operator, She's Out Of Reach, Shishkin, Sir Tiran, Sir Pirate, Spanish Present, Sparkling Dawn, Spells At Dawn, Spirit Of The Bay, Stage Star, Star Shield, Stately Home, Step Back.

Table with 2 columns: Race Name and Time. Races include Stevensen, Streets Of Doyen, Style Council, Surrey Mist, Swapped, Swarth Beach, Systemic, T'Arason, Tarnholm, Tejaano, Thais Toir, Thapa VC, The Bosses Oscar, The Shunter, The Spin King, Threeunderthrufive, Thyme White, Tiger Roll, Tikki Fire, Tiliworth Sammy, Tommy R, Top Dog, Top Moon, Torbellino, Torrent Des Mottes, Tour Est Permis, Tricolor, Tronador, True Accolade, Twilight Hair, Twilight Steel, Tyger Bay, Unexpected Party, Viva Devito, Watch Your Toes, Whatdeawant, Wheel Kitty, Yazaman, Ykikahobbis, Zhu Feng, Zumaaty.

1 08-162 HAXO (21) (BF) W P Mullins (IRE) 5 11-7 S O'Keeffe 129 SH 2-1fav (11-12) Led, pushed along 2 out, headed, ridden and no impression on winner, kept on one pace, 2nd of 16, 2 1/4 behind Walnut Beach (10-13) at Punch 2m mdn hdl

2 7-ID22 HEMLOCK (22) T Gibney (IRE) 5 11-7 D J O'Keeffe 131 H 9-4 (11-12) Led, travelling well 3 out, ridden after next, joined at last, headed final furlong, no extra, 2nd of 25, 1/4 behind Irish Blaze (11-12) at Navan 2m mdn hdl hvy
3 1-312 I AM MAXIMUS (74) (BF, C) (EW) N Henderson 6 11-7 N De Boinville 150 S 7-5fav (11-7) Chased winner, disputing lead off final bend, no impression final 100 yards, kept on, 2nd of 7, 21 behind Hillcrest (11-7) at Chelt 2m 4f Lstd nov hdl (1) sft
4 11-11 JOURNEY WITH ME (32) (F) H De Bromhead (IRE) 6 11-7 Rachael Blackmore 143 YS 4-11fav (11-10) Tracked leaders, improved to dispute lead at 3rd, led next and made rest, comfortably, won at Naas 2m 3f nov hdl sft bt Choice Of Words (11-5) by 3f
5 54022 SCARFACE (25) C Tizzard 5 11-7 B J Powell 137 S 12-1 (11-0) Held up midfield, smooth headway 4 out, pressed leader travelling best last, stayed on, 2nd of 8, nk bhd Skystatic (11-5) at Ascot 2m 3f nov hdl (2) sft
6 113-11 SIR GERHARD (38) (C) (SF) W P Mullins (IRE) 7 11-7 P Townend 158 YS 8-13fav (11-12) Led, mistake 3 out and last, ridden and asserted run-in, comfortably, won at Leopardstown 2m nov hdl G2 (1) in Feb bt Three Stripe Life (11-12) by 6f
7 23-111 STAGE STAR (77) (D) P Nicholls 6 11-7 H Cobden 152 S 5-4fav (11-7) Tracked leaders, switched 2 out, soon led, left in clear lead 2 out, stayed on strongly, won at Newbury 2m 4f nov hdl Grade 1 sft bt West Balboa (11-0) by 7f
8 14-122 THREE STRIPE LIFE (38) G Elliott (IRE) 6 11-7 D N Russell 151 YS 5-1 (11-12) Tracked leader, pushed along before last, mistake, ridden and no impression, kept on same pace, 2nd of 8, 6f behind Sir Gerhard (11-12) at Leap 2m nov hdl G2
9 13-15 WHATDEAWANT (73) W P Mullins (IRE) 6 11-7 D E Mullins 143 S 2-1 (11-12) Mid-division, progress 4 out, 3rd 2 out, soon ridden, no extra in closing stages, 5th of 7, 9f behind Ginto (11-12) at Naas 2m 4f nov hdl G2 (1) sft in Jan
BETTING: 8-11 Sir Gerhard, 5 Three Stripe Life, 11-2 Journey With Me, 6 Stage Star, 14 I Am Maximus, 20 Whatdeawant, 66 Scarface, Haxo, 100 Hemlock.

SINGLE-SHOT STAR (Top in-form jockey with just one booked ride) William Buick: TRUE ACCOLADE (6.00 Kempton).

TODAY'S FAB 4 TIPS
NORTHERNER'S NAP RED ALLURE (7.45 Newcastle) TOPSPOT GARRY CLERMONT (2.50 Cheltenham)
WEST COUNTRY'S BEST SWORD BEACH (3.10 Huntingdon) SPEEDHORSE AROUSING (7.30 Kempton)

WINNER MACHINE

BEACON TO FIRE UP FOR MEADE

BY **DANNY HALL**
NOEL MEADE sent out a big-race double at Naas on Sunday and his horses are in even better form coming into the Festival than some of his more lauded Irish compatriots. So it would be no surprise if his battle-hardened warrior **BEACON EDGE** ran a big race in the Brown Advisory Novices' Chase (2.10), having finished a typically gutsy fourth behind Flooring Porter in the Stayers' Hurdle last season. JP McManus has three towards at the head of the betting in

2.10 BROWN ADVISORY NOVICES' CHASE
(GRADE 1) (1) (5yo+) 3m Winner £98,473 (11 run) ITV/RTV



BIG GAME PLAYER
Bravemansgame is bidding to maintain his unbeaten record over fences



IN FORM Noel Meade the Coral Cup (2.50) - The Shunter, Drop The Anchor and **CAMPROND**, with conditions having come right for the Philip Hobbs trainee. A good ground horse, he has spent the winter in his stable following his excellent fourth in the Greatwood Hurdle over two miles of this track in November. Arguably better over 2m4f, and with the ground drying out this week, Camprond represents another in-form yard. It paid to be handy in the early Cheltenham races yesterday which bodes well for the front running **EDITEUR DU GITE**, a notably stylish jumper, in the Grand Annual Chase (4.50). **TODAY'S SELECTIONS**
Beacon Edge (ew)
2.10 Cheltenham
Camprond (ew)
2.50 Cheltenham
Editeur Du Gite (ew)
4.50 Cheltenham

BRAVE HEART

NEWSBOY'S 1-2-3
1 BRAVEMANSGAME
2 AHOY SENOR
3 FURY ROAD

BRAVEMANSGAME is expected to defend his unbeaten chase record - currently standing at 4-4. Podium finishes at Cheltenham and Aintree last spring marked the end of the seven-year-old's career over hurdles. Paul Nicholls, who once compared my selection with 2008 Cheltenham Gold Cup hero Denman, then sent the French-bred gelding over fences - with impressive results. Bravemansgame started off in an intermediate chase at Newbon Abbot in October, beating Fusil Raffles by five and a half lengths, and followed up from Itchy Feet in a graduation event at Haydock. He stepped up to the top level for Kempton's Kauto Star Novices' Chase on Boxing Day and jumped with panache in beating a

below-par **Ahoy Senior** by seven and a half lengths. And the Ditchet runner warmed up for today by carrying top weight to victory in a novices' handicap chase at Newbury last month. There is something thoroughly admirable about the way Harry Cobden's mount gets

things done and he hasn't finished yet - not by a long chalk. Ahoy Senior has since captured the Grade 2 Towton Novices' Chase Wetherby and isn't written off, while improving unbeaten chaser **L'Homme Presse** and top-level scorer **Fury Road** are others with a role to play.

STREET SMART
Fury Road may well make his presence felt



- 1** 1-U121 **AHOY SENOR** (39) (D)
L Russell 7 11-4 D R Fox 168 GS
8-11fav (11-5) Led until 7th, led 9th, drew clear from 3 out, landed a bit awkwardly 2 out, easily, won at Wetherby 3m nov chs G2 (1) gd in Feb bt Noble Yeats (11-0) by 6l
 - 2** F-21F2 **BEACON EDGE** (22)
N Meade (IRE) 8 11-4 S W Flanagan 167 H
7-2 (11-10) Tracked leaders, pushed along 3 out, kept on same pace in 2nd close home, 2nd of 4, 3/4 behind Farouk D'Alene (11-3) at Navan 3m nov chs G2 (1) hvy in Feb
 - 3** 2-1111 **BRAVEMANSGAME** (32) (D) (SF)
P Nicholls 7 11-4 H Cobden 174 GS
8-11fav (11-8) Made virtually all, stayed on strongly, impressive, won at Newbury 2m 7f nov Limited hcap ch (3) gs in Feb beating Pats Fancy (10-6) by 3/4l, 4 ran
 - 4** 41-12U **CAPODANNO** (38) (D)
W P Mullins (IRE) 6 11-4 M P Walsh 170 S
13-2 (11-10) Chased leader, 6th at 5th where mistake and unseated rider, in a race won by Galopin Des Champs (11-0) at Leopardstown 2m 5f nov chs G1 (1) in Feb
 - 5** 13-11 **DUSART** (42) (D)
N Henderson 7 11-4 N De Boinville 153 GS
2-7fav (11-8) Prominent, travelled strongly to lead at 4 out, kept on after final fence, won easily, won at Exeter 3m nov chs (3) gs in Feb bt Flash Collonges (11-2) by 11l
 - 6** 1-1221 **FAROUK D'ALENE** (22) (D)
G Elliott (IRE) 7 11-4 D N Russell 164 GY
4-11fav (11-3) Tracked leader, ridden 2 out, improved to lead final furlong, stayed on well close home, won at Navan 3m nov chs G2 hvy bt Beacon Edge (11-10) by 3/4l
 - 7** P-2315 **FURY ROAD** (38) (D)
G Elliott (IRE) 8 11-4 J W Kennedy 168 Y
9-1 (11-10) In touch, not fluent in 3rd at 7th, mistake 4 out, weakened before last, tailed off, 5th of 8, well behind Galopin Des Champs (11-0) at Leap 2m 5f nov chs G1
 - 8** 21-333 **GAILLARD DU MESNIL** (38)
W P Mullins (IRE) 6 11-4 P Townend 162 Y
33-1 (11-10) Towards rear, progress to 3rd 4 out, ridden and kept on one pace, 3rd of 8, 15l behind Galopin Des Champs (11-0) at Leap 2m 5f nov chs G1 (1) in Feb
 - 9** 6-1111 **L'HOMME PRESSE** (39) (C) (F)
V Williams 7 11-4 C Deutsch 171 GS
8-13fav (11-4) Pressed leader, led 11th made rest, went clear from 3 out, impressive, won at Sandown 2m 4f nov chs G1 (1) gs in Feb beating Mister Coffey (11-4) by 21l
 - 10** 7-13R3 **STREETS OF DOYEN** (11) (CD)
J McConnell (IRE) 8 11-4 S D Torrens 147 G
33-1 (11-1) Tracked leaders, ridden 3 out, disputed remote 2nd 2 out, 3rd before last, no impression, 3rd of 5, 18l behind Gentleman De Mee (11-1) at Navan 2m nov chs G3
 - 11** -21111 **THREUNDERTHRUFIVE** (60) (CD) (EW)
P Nicholls 7 11-4 A P Heskin 162 S
8-13fav (11-7) Made all, clear approaching 2 out, unchallenged, won at Warwick 3m nov chs G2 (1) sft in Jan beating Doyen Breed (11-2) by 3/4l, 5 ran
- BETTING:** 2 Bravemansgame, 10-3 L'Homme Presse, 5 Ahoy Senior, 8 Capodanno, 14 Gaillard Du Mesnil, Threunderthrufive, Fury Road, Farouk D'Alene.
2021: MONKFISH 7 11 4, Paul Townend 1-4 Fav (W P Mullins), 6 ran.

- NEWSBOY**
1.30 SIR GERHARD
2.10 BRAVEMANSGAME (NAP)
2.50 DROP THE ANCHOR
3.30 CHACUN POUR SOI
4.10 TIGER ROLL
4.50 AMARILLO SKY (NB)
5.30 AMERICAN MIKE
- BOUVIERIE**
1.30 SIR GERHARD
2.10 L'HOMME PRESSE (NAP)
2.50 FASTORSLOW
3.30 SHISHKIN
4.10 DELTA WORK
4.50 ANDY DUFRESNE (NB)
5.30 AMERICAN MIKE

JACKPOT MEETING

GOING: Good to Soft; Cross Country: Good to Soft-Soft in places.
COURSE: The old course is left-handed, oval, of a testing nature, one and a half miles in extent, with nine fences per circuit.
TOP TRAINERS: N Henderson 46-320 (14.4%), W P Mullins 31-272 (11.4%), G Elliott 30-185 (16.2%), P Nicholls 23-269 (8.6%), D Skelton 23-243 (9.5%), F O'Brien 22-181 (12.2%), N Twiston-Davies 22-239 (9.2%), C Tizzard 20-214 (9.3%), H De Bromhead 17-105 (16.2%), P Hobbs 11-165 (6.7%).
TOP JOCKEYS: Harry Skelton 23-193 (11.9%), Nico De Boinville 21-140 (15.0%), Sam Twiston-Davies 18-215 (8.4%), Paddy Brennan 18-160 (11.2%), Aidan Coleman 17-139 (12.2%), Harry Cobden 15-184 (8.2%), Paul Townend 14-84 (16.7%), Robbie Power 14-110 (12.7%).
TRAINER TARGETS (won today's race at least twice in last 10 years): G Elliott won the 1.30 in '18 and '20. W P Mullins won the 1.30 in '14 and '16. N Henderson won the 2.10 in '12, '17 and '20. W P Mullins won the 2.10 in '15 and '21. N Henderson won the 2.50 in '14, '19 and '20. H De Bromhead won the 3.30 in '17 and '21. N Henderson won the 3.30 in '12, '13, '16, '18 and '19. P Nicholls won the 3.30 in '15 and '20. G Elliott won the 4.10 in '17, '18 and '19. P Nicholls won the 4.50 in '16 and '18. G Elliott won the 5.30 in '17 and '19. W P Mullins won the 5.30 in '12, '13, '18, '20 and '21.
CHEEKPIECES: 2.10 Beacon Edge, Fury Road, 2.50 Garry Clermont, Grand Roi, Mars Harper, McFabulous, The Bosses Oscar, Tronador, 3.30 Put The Kettle On, 4.10 Alpha Des Obeaux, Brahma Bull, Easysland, Shady Operator, Step Back, 4.50 Gumball.
TONGUE STRAPS: 2.10 Capodanno, Fury Road, Streets Of Doyen, 2.50 Champagne Gold, Fastorslow, Ganapathi, The Bosses Oscar, The Shunter, 3.30 Envoi Allen, Nube Negra, Politologue, 4.10 Alpha Des Obeaux, Delta Work, Diesel D'Allier, Easysland, Poker Party, Step Back, Tiger Roll, Tout Est Permis, 4.50 Amarillo Sky, Buddy Rich, Capuccinix, Dancing On My Own, Destined To Shine, Elkir De Nutz, Embittered, Il Ridoto, Sky Pirate, 5.30 Joyeux Machin, Music Drive, Rosy Redrum, (=1st time).
1ST RUN SINCE WIND UP: 3.30 Envoi Allen.
1ST TIME HOODS: 5.30 Rosy Redrum.
PROFITABLE RACES FOR FAVS: 1.30.



TOP AMATEUR Patrick Mullins

IN FORM
TRAINERS: J Best & K Jewell 2-4 (50%), J O'Keefe 2-4 (50%), M Keighley 2-4 (50%), W P Mullins 14-33 (42%), A Brown 2-5 (40%), T Ward 2-5 (40%), A Baiding 7-18 (39%), A Murphy 2-6 (33%), C Appleby 4-13 (31%), N Twiston-Davies 7-23 (30%), P Hobbs 7-24 (29%), C Tizzard 7-25 (28%), M Harris 5-18 (28%), N Meade 3-11 (27%), P Nicholls 9-35 (26%), Alice Haynes 4-16 (25%), C Longsdon 3-13 (23%), G Elliott 10-45 (22%), D Skelton 8-38 (21%).
JOCKEYS: Connor Brace 4-5 (80%), Paul Townend 4-7 (57%), Joshua Bryan 3-6 (50%), Mr Patrick Mullins 3-6 (50%), Robbie Power 3-7 (43%), Aiden Brookes 2-5 (40%), Isabel Williams 2-5 (40%), Sean Flanagan 2-5 (40%), Tom Buckley 2-5 (40%), Mr Jamie Codd 3-8 (38%), Adam Farragher 2-6 (33%), Davy Russell 2-6 (33%), Harry Cobden 7-23 (30%), Jack Mitchell 6-20 (30%), Jack Mitchell 6-20 (30%), Sam James 3-10 (30%), David Egan 2-7 (29%), Rossa Ryan 4-15 (27%), Jason Watson 5-19 (26%).
PRO-BET AMERICAN MIKE
(5.30 Cheltenham) 2pts win

2.50 CORAL CUP H'CAP HURDLE

(GRADE 3) (1) (4yo+) 2m5f Winner £56,270 (26 run) ITV/RTV

ANCHOR FLUTTER

NEWSBOY'S 1-2-3
1 DROP THE ANCHOR
2 THE SHUNTER
3 INDIGO BREEZE



DROP THE ANCHOR caught the eye with a strong finish at Leopardstown last month and makes appeal in a wide-open race.

Pat Fahy's (right) son of Shantou has already shown his mettle in big-field handicaps, lifting a valuable two-mile contest for jockey Simon

Torrens at Leopardstown's Dublin Racing Festival in February of last year.

The JP McManus-owned eight-year-old is without a win in four starts over obstacles since, but wasn't

beaten far when seventh in the County Hurdle here 12 months ago.

Although down the field at Punchestown – and when ninth to Tritonic in a big-money event at Ascot a week before Christmas – Drop The Anchor showed green shoots in south Dublin last time out.

Again ridden by Torrens, who claims a valuable 3lb here, my selection came home with gusto to take fifth, beaten just over 10 lengths, to Call Me Lyreen.

His three hurdles wins have been over two miles, but Drop The Anchor is



WINNING FORM
 Groom Rachel Robbins and jockey Simon Torrens after Drop The Anchor won the Ladbrokes Hurdle

well worth this return to further and a good account is on the cards.

The Coral Cup shortlist is invariably a long one, with **The Shunter**, **Unexpected Party**, **Indigo Breeze** and **Ashdale Bob** just four horses worth a second look.

- 1** -232PP **THE BOSSES OSCAR** (53)
G Elliott (IRE) 7 11-12 **Mr R James (7)** 156 GS
 3-1 (12-0) Rear, jumped slowly throughout and mistakes, hampered 12th and pulled up before next, in a race won by Champagne Platinum (12-0) at Navan 3m beg chase
- 2** -U3732 **ASHDALE BOB** (22)
J Harrington (IRE) 7 11-10 **Jack Foley (3)** 158 H
 9-2 (11-8) Led, headed 4 out, led again 3 out, strongly pressed final furlong, headed and no extra, 2nd of 9, hd bhd The Devilscoachman (11-6) at Navan 2m 5f hdl G2 hvy
- 3** 5F1P83 **COMMANDER OF FLEET** (22) (B) (D)
G Elliott (IRE) 8 11-10 **S Fitzgerald (5)** 157 Y
 16-1 (11-3) Tracked leaders, ridden in 5th 2 out, no impression on leaders at last, kept on same pace, 3rd of 9, 10l bhd The Devilscoachman (11-6) at Nav 2m 5f hdl G2 hvy
- 4** 128-24 **MCFABULOUS** (46) (D)
P Nicholls 8 11-8 **H Cobden** 157 S
 5-1 (11-6) Kept wide in 4th, every chance 2 out, pushed along out wide before the last, soon weakened, 4th of 5, 25l behind Paisley Park (11-6) at Chelt 3m hdl G2 qd
- 5** 1-12 **SAINT FELICIEN** (45) (BF)
G Elliott (IRE) 5 11-7 **R M Power** 154 GY
 4-5fav (11-7) Tracked leaders, headway to dispute lead 2 out, soon ridden, headed at last, kept on same pace run-in, 2nd of 6, 3½l bhd Darasso (11-12) at Naas 2m hdl G3
- 6** 20-344 **GRAND ROI** (22)
G Elliott (IRE) 6 11-7 **D N Russell** 158 G
 6-1 (11-8) Tracked leader, led 4 out, ridden and headed 3 out, mistake at last, 4th of 9, 12l behind The Devilscoachman (11-6) at Navan 2m 5f hdl G2 (1) hvy in Feb
- 7** -12127 **HANG IN THERE** (151) (C)
E Lavelle 8 11-6 **J A Anderson (7)** 159 G
 11-1 (10-13) Prominent, ridden and outpaced before 3 out, weakened, 7th of 12, 20l behind Glory And Fortune (10-7) at Ffos Las 2m hcp hdl (2) qd in Oct
- 8** 123-4U **THE SHUNTER** (38) (H) (CD)
E Mullins (IRE) 9 11-6 **M P Walsh** 157 GY
 8-1 (11-6) Rear, mistake and unseated rider at 6th, in a race won by Birchdale (9-7) at Leopardstown 2m 5f hcp chs in Feb, 17 ran
- 9** 0-6132 **GOWEL ROAD** (54) (CD)
N Twiston-Davies 6 11-3S **Twiston-Davies** 157 H
 17-2 (11-12) Led until after 1st, chased leaders, hung under pressure between last two, stayed on same pace, 2nd of 12, 1¼l behind Metier (11-10) at Ling 2m hcp hdl (2) hvy
- 10** 5-2144 **DALY TIGER** (25)
N Meade (IRE) 9 11-3 **E Walsh (3)** 147 H
 9-2 (11-3) Tracked leader, 2nd after 9th, slow jump at 10th dropped to 3rd, weakened to rear before last, last of 4, 27l behind Melon (11-3) at Gowran 2m 4f chs G2 hvy
- 11** 1250F- **GANAPATHI** (320)
W P Mullins (IRE) 6 11-3 **B J Cooper** 143 H
 15-2 (11-12) Tracked leaders, disputed 3rd at halfway, pushed along straight, chance when fell at last, won by Gaillard Du Mesnil (11-12) at Punch 2m 4f nov hdl G1 in Apr
- 12** -34622 **CHRISTOPHER WOOD** (25)
V Williams 7 11-1 **H Bannister** 157 GS
 16-1 (11-9) Prominent, led 3 out, ridden and headed 2 out, stayed on but no match for winner, 2nd of 11, 9l behind Good Risk At All (10-9) at Ascot 2m 3f hcp hdl (2) sft
- 13** 170-95 **DROP THE ANCHOR** (38)
P A Fahy (IRE) 8 11-1 **S D Torrens (3)** 160 GS
 33-1 (11-7) Mid-division, headway straight, ran on well run-in to 5th close home, never nearer, 5th of 27, 10l behind Call Me Lyreen (11-4) at Leopardstown 2m hcp hdl

- 14** -21453 **DANS LE VENT** (39)
E Williams 9 11-0Isabel Williams (3) 158 S
 13-2 (10-13) Held up, pushed along and struggling 3 out, headway 2 out, no chance with leading duo, 3rd of 17, 8l bhd Green Book (10-6) at Sand 2m 7f hcp hdl G3 gs
- 15** -41221 **UNEXPECTED PARTY** (53) (D) (F)
D Skelton 7 11-0 **H Skelton** 155 S
 3-fav (10-13) Rear, smooth headway 3 out, clear when dived at the last, very easily, won at Ascot 2m 3f hcp hdl (2) sft in Jan beating Filis Doudairies (11-7) by 4½l
- 16** 3-1233 **GARRY CLERMONT** (53)
Jonjo O'Neill 7 11-0 **Jonjo O'Neill Jr** 161 S
 9-2 (11-12) Mid-division, headway chasing leaders 3 out, 3rd and one pace between last two, 3rd of 11, 9l bhd Unexpected Party (10-13) at Ascot 2m 3f hcp hdl (2) sft
- 17** 3-4P36 **CALL ME LORD** (39) (C, D)
N Henderson 9 11-0 **D Jacob** 159 GS
 12-1 (11-6) Mid-division, struggling rear 3 out, headway and mistake 2 out, stayed on same pace, 6th of 17, 21l behind Green Book (10-6) at Sandown 2m 7f hcp hdl G3 gs
- 18** 1/2-00 **FASTORSLOW** (38) (EW)
M Brassil (IRE) 6 10-13 **D J O'Keeffe** 146 YS
 33-1 (11-5) Mid-division, 14th before 4 out, no impression before last, kept on same pace run-in, 12th of 27, 25l behind Call Me Lyreen (11-4) at Leap 2m hcp hdl
- 19** 142114 **CAMPOND** (122) (C)
P Hobbs 6 10-12 **A Coleman** 156 G
 17-2 (11-5) Tracked leaders, stumbled badly 3 out, ridden before the last, no impression run-in, 4th of 19, 6l behind West Cork (10-13) at Cheltenham 2m hcp hdl G3 (1) qd
- 20** 128-12 **INDIGO BREEZE** (60) (H) (BF)
G Elliott (IRE) 6 10-12 **J Gainford (3)** 150 S
 9-4fav (11-7) Tracked leaders, mistake 2 out, ridden to go 2nd at last, kept on well final furlong, 2nd of 5, 2¾l bhd Autumn Evening (11-7) at Fairy 2m hdl sft
- 21** 00-570 **CHAMPAGNE GOLD** (38)
H De Bromhead (IRE) 7 10-11Rachael Blackmore 147 SH
 33-1 (11-2) Rear, effort before last, kept on same pace run-in, no danger, 15th of 27, 34l behind Call Me Lyreen (11-4) at Leopardstown 2m hcp hdl in Feb
- 22** F3PP30 **TOP MOON** (39)
B Haslam 7 10-11 **R McLernon** 145 S
 33-1 (11-2) Tracked leader, pushed along and lost place approaching 2 out, weakened, tailed off, 18th of 24, well behind Good Time Jonny (10-13) at Leap 3m hcp hdl
- 23** 01-006 **MAZE RUNNER** (39)
W P Mullins (IRE) 7 10-11 **S O'Keeffe** 150 SH
 20-1 (10-13) Tracked leaders, led before 2 out, ridden and headed last, soon no extra, 6th of 24, 1l behind Good Time Jonny (10-13) at Leopardstown 3m hcp hdl in Feb
- 24** /710-P **TRONADOR** (229)
G Elliott (IRE) 6 10-10 **S Ewing (3)** 152 GS
 25-1 (10-8) In rear, not fluent at 1st, soon reminder, niggled along, detached at 8th, pulled up before next, in a race won by Jazzaway (10-5) at Galway 2m 7f hcp hdl qd
- 25** /2-151 **FAIR FRONTIERES** (32) (D)
K Bailey 7 10-9 **D Bass** 151 GS
 5-1 (11-7) Made all, not fluent when pressed 2 out, not fluent last, driven out, won at Warwick 2m 5f nh nov hdl (4) gs in Feb beating Earth Lord (11-7) by 1¼, 3 ran
- 26** 125527 **MARS HARPER** (53) (BF)
G Elliott (IRE) 6 10-9 **J W Kennedy** 153 YS
 4-fav (10-10) Tracked leaders, ridden in 5th 3 out, soon no impression, 7th of 17, 10l behind The Very Man (11-1) at Navan 2m 4f hcp hdl in Jan

BETTING: 13-2 Saint Felicien, 15-2 Drop The Anchor, The Shunter, 8 Unexpected Party, 10 Campond, 12 Gowel Road, 14 Grand Roi, Indigo Breeze, Fastorslow.
 2021: HEAVEN HELP US 7 10 9, Richard Condon(7) 33-1 (P Hennessy), 26 ran.

CHELTENHAM...

TOP PRICE GUARANTEE

ON THE QUEEN MOTHER CHAMPION CHASE
 CHELTENHAM 3.30PM

TAKE TIME TO THINK
 takimetothink.co.uk

Available in-shop and online. Top prices from 9am 4/3/22 until the start of each of the 3 championship races compared to selected competitors. Standard win market odds only. Excludes competitor offers. Further terms apply.

3.30 BETWAY QUEEN MOTHER CHAMPION CHASE

(GRADE 1) (1) 2m Winner £225,080 (8 run) ITV/RTV

- 1** 131-51 **CHACUN POUR SOI** (38) (D)
W P Mullins (IRE) 10 11-10 **Mr P W Mullins** 185 Y
 4-7fav (11-12) Led, not fluent at 7th, increased advantage last, clear run-in, kept on well, easily, won at Leap 2m 1f chs G1 (1) in Feb beating Dunvegan (11-12) by 12l
- 2** 111-12 **ENERGUMENE** (53) (D) (F)
W P Mullins (IRE) 8 11-10 **P Townend** 186 S
 5-4 (11-7) Led, over 1 length ahead jumping 2 out, 2 lengths clear at the last, headed and no extra final 50 yards, 2nd of 4, 1l bhd Shishkin (11-7) at Ascot 2m 1f ch G1 stf
- 3** FP-161 **ENVOI ALLEN** (79) (CD)
H De Bromhead (IRE) 8 11-10 **Rachael Blackmore** 167 GY
 2-5fav (12-0) Prominent and led after 2nd, slight mistake 2 out, ridden and kept on well run-in, won at Leap 2m 1f chs G1 (1) in Dec bt Battleoverdoyen (12-0) by 8l
- 4** 2-2911 **FUNAMBULE SIVOLA** (32) (D)
V Williams 7 11-10 **C Deutsch** 168 GS
 9-4 (11-0) Made all, hit 6th, quickened and came clear 2 out, kept on strongly, unchallenged, won at Newbury 2m chs G2 (1) qs beating Sceau Royal (11-6) by 2l
- 5** 123-14 **NUBE NEGRA** (102) (CD) (EW)
D Skelton 8 11-10 **H Skelton** 175 G
 4-1 (11-7) Bit keen, chased leaders on inside, not fluent 5th, outpaced 3 out, never dangerous after, 4th of 5, 12l bhd Greaneteen (11-7) at Sand Im 7f G1 chs (4yo+) qs
- 6** /124-2 **POLITOLOGUE** (122) (CD)
P Nicholls 11 11-10 **H Cobden** 168 S
 5-1 (11-6) Led, joined 2 out, headed soon after, 2 lengths down last, stayed on same pace, 2nd of 4, 6l behind Nube Negra (11-6) at Cheltenham 2m G2 chs (4yo+) gd
- 7** 111-11 **SHISHKIN** (53) (CD) (SF)
N Henderson 8 11-10 **N De Boinville** 187 S
 5-6fav (11-7) Tracked leaders, went 2nd 5th, bad stumble next, 2 lengths down last, ridden and stayed on to lead, won at Asc 2m 1f chs G1 stf bt Energumene (11-7) by 1l
- 8** 314-35 **PUT THE KETTLE ON** (74) (CD)
H De Bromhead (IRE) 8 11-3 **A Coleman** 172 GS
 9-2 (11-9) In touch in last, went 4th at 7th, last and trailing 2 out, last of 5, 42l behind Mount Ida (11-5) at Fairyhouse 2m 5f mares chs Grd 3 (1) in Jan

BETTING: 4-5 Shishkin, 7-2 Energumene, 5 Chacun Pour Soi, 12 Nube Negra, 20 Envoi Allen, Put The Kettle On, 33 Funambule Sivola, 50 Politologue.
 2021: PUT THE KETTLE ON 7 11 3, Aidan Coleman 17-2 (H De Bromhead), 9 ran.

STAT OF THE DAY
 Trainer Sam Thomas and jockey Sam Twiston-Davies have a 50 per cent strike rate together at Cheltenham – two wins from four runners for a level-stake profit of 12.58pts. So look out for **BEFORE MIDNIGHT** (4.50).



POINT TO PROVE
 Chacun Pour Soi must overcome previous flops



REVENGE BID
 Energumene has a score to settle with Shishkin

CHAC'S THE LAD FOR ME



it's who you play with



NEWSBOY'S 1-2-3

- 1 CHACUN POUR SOI**
- 2 SHISHKIN**
- 3 FUNAMBULE SIVOLA**

CHACUN POUR SOI has flopped on his previous two visits to Britain but gets the vote to make it third time lucky and gatecrash the **Shishkin-Energumene** reunion party.

A year ago, punters made Willie Mullins' 10-year-old the 8-13 favourite to mark his first appearance on this shores with success in the Queen Mother Champion Chase.

But Chacun Pour Soi ran below market expectations in third behind **Put The Kettle On** and **Nube Negra**, and it was a similar story at the same odds when he trailed in last of five behind Greaneteen in the top-level Tingle Creek Chase at Sandown in December.

But those runs are no reflection whatsoever of



PROVEN FORM
 Unbeaten Shishkin is bidding for a third Festival win

Chacun Pour Soi's ability – as he showed when powering home by 12 lengths to rack up a hat-trick in the Dublin Chase at Leopardstown last month.

After that win, Mullins unveiled his theory that Chacun Pour Soi finds crossing the Irish Sea unusually taxing and resolved to leave the horse one gallop short of fitness

before his departure from Clouston.

It's an ambitious plan but Mullins hasn't won 15 trainers' titles in his homeland by accident, and it's worth taking the chance at the prevailing odds that it comes off.

Shishkin got the better of my selection's stablemate Energumene in a thriller for the Clarence House Chase at Ascot in January and the view that Cheltenham's left-handed layout and stiff uphill finish will help him stay on top is a persuasive one.

Politologue won this two years ago but is performing below that level these days, and **Envoi Allen** has long since lost his aura of invincibility.

Those seeking to play at more remunerative odds could do worse than **Funambule Sivola**. Venetia Williams' seven-year-old has it to do on the ratings, but is heading in the right direction and still looks capable of building on the form that saw him lift Newbury's Grade 2 Game Spirit Chase last time out.

**DON'T MISS
ANOTHER
AMAZING
OFFER**

William HILL

**£2
bet**

**VALID ON ANY
SPORT**

**PLUS 12-page pullout packed with
Cheltenham tips and coverage**

INSIDE TOMORROW'S

**Daily
Record**

18+ Terms apply. See tomorrow's paper for full details.

GARRY OWEN'S DAY TWO VERDICT

Hit bookies for six with a L'Homme run

FROM PUNTER FRONT

his account by routing solid yardstick Gunsight Ridge at Exeter in December. But he really hit the headlines when hammering **Legends Ryde** up in class at Ascot next time.

That romp earned the seven-year-old a tilt at the Grade 2 Dipper Novices' Chase over track and trip.

And he justified that promotion with a commanding defeat of class act **The Glancing Queen** before delivering the goods again with a devastating 21-length demolition of **Mister Coffey** at the Grade 1 Scilly Isles Chase at Sandown.

He was staying on powerfully over a stiff 2m 4f so can destroy a top-class field up in trip.

JOURNEY WITH ME (1.30) can slay warm favourite Sir Gerhard in the Ballymore Novices' Hurdle.

A switch to timber saw Henry De Bromhead's gelding slam the talented **Minella Crooner** on debut at Leopardstown. He looks every inch a Grade 1 performer so can power home under Rachael Blackmore.

SAINT FELICIEN (2.50) can be simply divine for Gordon Elliott in the ever-competitive Coral Cup. The five-year-old ran a stormer when chasing home **Darasso** in Grade 3 company at Naas. This big prize has clearly been the plan ever since so he can go one better under Robbie Power.

The Meath Maestro can also bag the Glenfarclas Cross-Country Chase with **DELTA WORK** (4.10). The nine-year-old has schooled well over these unique fences so he can upstage stablemate **Tiger Roll**.

Elliott can make it three with **AMERICAN MIKE** (5.30) in the Weatherbys Champion Bumper.

The five-year-old oozed promise when bolting up from **High Class Hero** in a strong Cork point then downing **Battling Bessie** in Listed company at Navan.

There is plenty more to come from this pacy type who can see off market rival **Facile Vega**.

SHISHKIN (3.30) can cement his superstar status by landing the Queen Mother Champion Chase.

Nicky Henderson's gelding was utterly merciless when winning last year's Arkle over track and trip.

He then added another Grade 1 to his CV when slamming **Funambule Sivola** at Aintree.

Wind surgery and an early setback meant he was not seen again until Kempton in December.

But the eight-year-old showed no ill effects as he hacked up from the classy **Greaneteen**. That put him on



LEADING THEM ALL L'HOMME
Presse has barely put a foot wrong this season

a collision course with Irish star Energumene in the Clarence House at Ascot. He wasn't at his brilliant best but knuckled down well to deny his opponent by a length.

The son of Sholokhov will now be at peak fitness so he can dish out a heavier beating to his old foe.

BEFORE MIDNIGHT (4.50) can cap Sam Thomas's superb season by taking the Grand Annual Chase.

The nine-year-old showed class and guts to fend off **Amoola Gold** in a competitive event at Ascot and gave the talented **Funambule Sivola** most resistance at Doncaster. He looks open to plenty of progress so can make light of a career high mark.

PALLAS DANCER (5.45) can put his best foot forward for Brian Ellison on the Flat at Newcastle. The five-year-old looked as good as ever when

narrowly beaten by **Wise Eagle** over 1m 4f here and is just as effective over 1m 2f so can go one better in another trappy handicap.

The All-Weather Mile Handicap is even trickier but I'm on James Ferguson's **DIDEROT** (6:15).

The four-year-old was an excellent second to **My Oberon** in conditions company at Southwell. That is smashing form so he can resume the winning thread dropped in class.

PROCLAIMER (7.0) can call the tune for Julie Camacho in the Unibet Handicap at Kempton.

The five-year-old returned with a gritty defeat of Baldomero over this course and distance so he can shrug off a lenient 3lb penalty.

JUST IN TIME (8.0) can continue Alan King's ongoing revival in a competitive two-miler.

SCOT A DAY



STAT'S THE ONE
Bartlett and Stattler
jockey Patrick Mullins

Honeysuckle a star as Tartan winners shine

HONEYSUCKLE headlined a magnificent afternoon for Scotland on Day One at Cheltenham.

The superstar was an 8-11 jolly to land her second straight Champion Hurdle for Ayrshire's Kenny Alexander.

The owner never had a moment's worry as she travelled brilliantly under old ally Rachael Blackmore.

Henry de Bromhead's mare eased to the front two out and she slammed Epatante (16-1) by three lengths.

Alexander said: "That was such an amazing thrill but I'm glad it's all over!"

"If you don't get nervous on days like today, what's the point? I always get nervous even if they're at Tramore or Carlisle."

"It feels special this year with the crowd back and my wife Caroline here for the first time. She's a dream horse. "Having the crowd cheering for her is better than having them against you, I can tell you that!"

"She's had a great reception in Ireland and now she's had one here."

Lanarkshire-born trainer Alan King added to the tartan tally with the brave Edwardstone in the Arkle.

The 5-2 favourite was almost brought down at the third before nearly colliding with Riviere D'Etel two out. But jockey Tom Cannon clung on and the race was over when they powered clear at the last.

Gabynako (25-1) tried to challenge but he was no match for the jolly who



RAM RAIDER Fox, left, and Russell, centre, with winner Corach Rambler



OPENING WINS
Celebrations for De Bromhead and jockey Blackmore, top, and Cannon on Edwardstone

GARRY OWEN'S DAY ONE REVIEW

bolted up by four lengths. King said: "I'm just relieved. We missed the carnage at the third. We could easily have been brought down."

"He's done it well and Tom Cannon has given him a cracking ride."

Lucinda Russell made it three for Scotland when Corach Rambler left it late to land the Ultima Chase.

The 10-1 shot was held up as usual

by Derek Fox but stealthily moved into contention on the second circuit. He still had plenty to do two out but made rapid headway to collar Gericault Roque (9-1) at the last.

The eight-year-old then stormed up the hill to give the Arlary Ace her first Festival win since 2015 by three lengths. Russell said: "It means so much. It's not just having a winner at

Cheltenham, which means a lot, but it's about the horse and the owners, a lot of whom haven't had a horse before.

"It's amazing. He could be a Grand National horse next year, definitely."

Stattler completed a wonderful day for Scotland as the Ronnie Bartlett-owned Stattler won the National Hunt Chase, getting trainer Willie Mullins off the mark after a disappointing day

for the Irishman. It was a third success in the race for owner Bartlett following Rathvinden (2018) and Galvin last year and proved to be the perfect prelude before his star's Gold Cup bid on Friday.

Constitution Hill (9-4) threw down the gauntlet to Honeysuckle with a blistering win in the Supreme Novices' Hurdle.

Nicky Henderson's star set up a fascinating duel after routing Jonbon (8-1) by 22 lengths under Nico de Boinville.

ONE FOR EVERYONE

£1 FREE BET TODAY
AT THE CHELTENHAM
FESTIVAL

Available at [Ladbrokes.com](https://www.ladbrokes.com)

Ladbrokes

4.10 GLENFARLCAS CHASE (CROSS COUNTRY)

(2) (5yo+) 3m6f Winner £39,023 (16 run) ITV/RTV

- 1 **P89U80 ALPHA DES OBEAUX (31)**
G Elliott (IRE) 12 11-4 J McGarvey 92 S
28-1 (11-4) Prominent, disputed lead 4th, towards rear 4 out, no extra, weakened, 13th of 15, well bhd Midnight Maestro (12-0) at Punch 3m 1f crs cntry chs (5yo+) hvy
- 2 **171515 BACK ON THE LASH (96) (BF, CD)**
M Keighley 8 11-4 S Bowen 148 G
10-3fav (10-6) Chased leader until 4th, weakened 2 out, 5th of 15, 18l behind Diesel D'Allier (10-2) at Cheltenham 3m 6f hcp chs (2) gs in Dec
- 3 **02333P BRAHMA BULL (48)**
W P Mullins (IRE) 11 11-4 B Hayes 163 G
33-1 (11-6) Always towards rear, mistake 3rd, under pressure 9th, pulled up before 3 out, in a race won by Longhouse Poet (10-9) at Gowran Park 3m 1f hcp chs sft
- 4 **U3-466 DELTA WORK (39) (C) (F)**
G Elliott (IRE) 9 11-4 J W Kennedy 173 Y
12-1 (11-10) Tracked leaders, pushed along and towards rear 3 out, no impression, no extra run-in, 6th of 8, 16l behind Conflated (11-10) at Leap 3m chs G1 (1) in Feb
- 5 **236-31 DIESEL D'ALLIER (96) (CD) (EW)**
R Bandey 9 11-4 H Bannister 150 GS
6-1 (10-2) Mid-division, headway chasing leaders 30th, strong challenge run-in, led post, won at Chelt 3m 6f hcp chs (2) gs bt Potters Corner (9-11) by ns
- 6 **/42-PP EASYSLAND (25) (CD)**
Jonjo O'Neill 8 11-4 Jonjo O'Neill Jr 154 S
66-1 (11-9) In rear, ridden and detached after 4th, tailed off 6th, pulled up before 4 out, in a race won by Good Risk At All (10-9) at Ascot 2m 3f hcp hdl (2) sft in Feb
- 7 **4-2091 MIDNIGHT MAESTRO (31)**
E Bolger (IRE) 10 11-4 L Dempsey 149 H
9-2 (12-0) Tracked leaders, mid-division halfway, progress 2 out, ridden and kept on best, won at Punch 3m 1f crs cntry chs (5yo+) hvy bt Shady Operator (12-0) by nk
- 8 **13-P00 MITCHOUKA (31)**
J Dreaper (IRE) 8 11-4 K M Donoghue 115 GY
10-1 (12-0) Tracked leaders, no impression in mid-division 5 out, no extra after 2 out, 10th of 15, 34l bhd Midnight Maestro (12-0) at Punch 3m 1f crs cntry chs (5yo+) hvy
- 9 **F7-043 PLAN OF ATTACK (96) (B)**
H De Bromhead (IRE) 9 11-4 D J O'Keefe 147 S
9-2 (10-3) Soon towards rear, headway chasing leaders 20th, stayed on same pace in 3rd run-in, 3rd of 15, 4l behind Diesel D'Allier (10-2) at Chelt 3m 6f hcp chs (2) gs
- 10 **143/00 POKER PARTY (48)**
H De Bromhead (IRE) 10 11-4 Rachael Blackmore 115 S
16-1 (11-8) Mid-division on outer, ridden 8th, weakened, 12th of 18, well behind Kells Priory (9-13) at Gowran Park 2m 4f cond hcap hdl sft in Jan
- 11 **76P2P0 POTTERS CORNER (18)**
Christian Williams 12 11-4 J Tudor 148 H
40-1 (10-13) Midfield, mistake 7th, blundered 20th, pushed along 22nd, soon weakened, 14th of 16, 50l behind Win My Wings (11-0) at Newcastle 4m 1f hcp chs (2) gs in Feb
- 12 **-11110 PRENGARDE (17)**
E Bolger (IRE) 6 11-4 M P Walsh 145 S
22-1 (11-9) Always towards rear, no danger from 4 out, never a factor, tailed off, 18th of 21, well behind Palace Rock (11-7) at Naas 1m 7f hcp hdl sft in Feb
- 13 **609102 SHADY OPERATOR (31)**
E Bolger (IRE) 9 11-4 Mr D O'Connor 153 GY
5-2 (12-0) Led, strongly pressed before last and headed, kept on, not match winner, 2nd of 15, nk bhd Midnight Maestro (12-0) at Punch 3m 1f crs cntry chs (5yo+) hvy
- 14 **116-73 STEP BACK (39)**
M Bradstock 12 11-4 N De Boinville 133 GS
7-1 (10-10) Tracked leaders, led 3rd, pushed along and headed 4 out, stayed on one pace, 3rd of 6, 23l behind Captain Cattistock (9-12) at Muss 3m 7f hcp chs (2) gd
- 15 **614-PO TIGER ROLL (53) (B) (CD) (SF)**
G Elliott (IRE) 12 11-4 D N Russell 172 GS
28-1 (11-5) Always towards rear, ridden in moderate 14th 3 out, soon no impression, never a factor, 14th of 17, 31l behind The Very Man (11-1) at Navan 2m 4f hcp hdl
- 16 **P-5903 TOUT EST PERMIS (31) (BF)**
N Meade (IRE) 9 11-4 S W Flanagan 153 Y
15-8fav (11-4) Mid-division, headway into 3rd 3 out, ridden and kept on one pace run-in, 3rd of 15, 8l bhd Midnight Maestro (12-0) at Pun 3m 1f crs cnt chs (5yo+) hvy

BETTING: 13-8 Tiger Roll, 6 Delta Work, 13-2 Prengarde, 8 Shady Operator, 10 Easysland, 12 Midnight Maestro, 14 Diesel D'Allier, Brahma Bull.
2021: TIGER ROLL 11 11 4, Keith Donoghue 9-2 (Mrs D Foster), 13 ran.

ONE LAST ROLL OF THE DICE...

NEWSBOY'S 1-2-3

- 1 TIGER ROLL
- 2 DELTA WORK
- 3 BACK ON THE LASH

TIGER FEAT
Tiger Roll is aiming for a staggering sixth win at the Festival



TIGER ROLL, in what has been advertised as his career valediction, is in the right place to go out in a blaze of glory.

In recent years, too many column inches have been devoted to owner Michael O'Leary's multiple beefs over the little hero's Grand National weight.

But that must not detract from the fact the Gordon Elliott trainee has been the most popular National Hunt horse of the past decade, with two Aintree triumphs and five Cheltenham Festival victories on his CV.

Three of those have been in this race, including an 18-length humbling of Easysland 12 months ago.

That performance came on the back of a couple of uninspiring efforts – a resurgence Elliott

attributes to Tiger Roll's effectiveness over Cheltenham's banks and hedges, and a preference for spring ground.

It has been a similar story this winter as Tiger

Roll pulled up behind Cheltenham Gold Cup hope Protektorat at Aintree in December and then ran down the field in a Navan handicap hurdle.

But Cheltenham is his

stage and, with old ally Davy Russell in the plate for the final act, Tiger Roll is expected to bring the house down.

Stable companion Delta Work is a class act over

regulation fences and, reported to have taken like a duck to water to his new discipline, rates a threat, ahead of Shady Operator and Back On The Lash.

SPOTFORM GOINGS

Heavy - H; Soft - S; Good to soft - GS; Good - G; Good to firm - GF; Firm - FM; Hard - HD; Yielding - Y; Yielding to soft - YS; A-W: Standard - ST; Slow - SL; Standard to fast - SF, Standard to slow - SS



SPECIAL TRIP
Journey With Me can take the Ballymore

ENJOY the Journey in the Ballymore Novices' Hurdle.

Sir Gerhard might well go off odds-on but he's got to prove his jumping and stamina are up to the job.

Unbeaten **JOURNEY WITH ME** (1.30) trained by Henry De Bromhead (below) looks much better value.

He made it two from two over hurdles despite the snail-like early pace at Naas last month.

His earlier defeat of Minella Crooner and Kilcruit has worked out well and his proven staying power could be key.

Have 2pts to win at **8-1**.

The Coral Cup is as competitive as ever and it might be worth chancing **DALY TIGER** (2.50) at monster odds for in-form Irish trainer Noel Meade.

He is well treated on his chase form and he was successful over hurdles on Boxing Day. To give weight and a beating to useful novice Choice Of Words at Limerick was a decent effort.

It's probably not wise to get bogged down with his two

JOURNEY'S END WILL BE AT A HAPPY PLACE

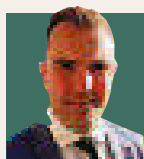

VALUE SCOPE

STEVE JONES with FOUR top tips

subsequent runs as he made mistakes over fences in one and the trip was too short in the other.

Have 1pt each-way at **66-1**, with Sky Bet paying out on eight places and others stretching to seven.

The Grand Annual is a tricky puzzle but **BEFORE MIDNIGHT** (4.50) looks the right type for this 2m handicap chase. He

made it four wins on the bounce when holding off Amoola Gold at Ascot in November having earlier beaten last year's Grand Annual winner Sky Pirate over this course and distance.

The form of his length second behind Funambule Sivola at Doncaster in January got a boost when the winner followed up in Newbury's Game Spirit so it's easy to

argue he's still progressing. Have 1pt each-way at **14-1**.

Willie Mullins has the red-hot favourite Facile Vega as he attempts to make it a dozen Champion Bumper wins but he has never landed this race with his first string when he has more than one runner.

The Irish champion trainer also bred **SEABANK BISTRO** (5.30) and he makes more appeal on his 2m3f Naas debut win.

If the forecast heavy afternoon rain hits the track, he'll need that stamina but he's not short on speed.

Have 1pt each-way at **40-1** with most bookies paying four places.

4.50 GRAND ANNUAL CHASE

(GRADE 3) (1) 2m Winner £70,338 (20 run) RTV

THIS IS THE WAY
Amarillo Sky knows where the winners' enclosure is found



LO & BEHOLD

NEWSBOY'S 1-2-3
1 **AMARILLO SKY**
2 **BUDDY RICH**
3 **BEFORE MIDNIGHT**

AMARILLO SKY is fancied to rack up his fourth – and most significant – prize of a fruitful campaign.

Successful over hurdles

in May, the Colin Tizzard-saddled son of Westerner was sent over fences in November and hit the ground running with a length-and-a-half novice handicap chase score from Thyme White at Wincanton.

Second in the same sphere at Ascot eight days before Christmas, Amarillo Sky was travelling with ominous

ease when departing at the second-last at Newbury in mid-January.

But Brendan Powell's mount made handsome amends at the Berkshire course last time, sprinting clear on the final to the final obstacle to beat Shakem Up'Arry by an increasing 10 lengths.

Under the circumstances, an 8lb rise in the weights was to be

expected and Amarillo Sky has plenty of as-yet untapped potential to draw upon.

The Gordon Elliott pair **Andy Dufresne** and **Buddy Rich** have been well backed for this test and must enter calculations, while **Before Midnight** and dual Cheltenham winner **Editeur Du Gite** are others to throw into the melting pot.

- 1 -24324 **SKY PIRATE** (32) (CD) (EW)
Jonjo O'Neill 9 11-12 N Scholfield 164 S
8-1 (11-4) Tracked winner until 4th, chased leading pair until 5 out, 3rd again next, weakened 2 out, last of 4, 12l bhd Funambule Sivola (11-0) at Newb 2m chs G2 (1) gs
- 2 113P-2 **ANDY DUFRESNE** (130) (D)
G Elliott (IRE) 8 11-11 M P Walsh 161 GY
9-4 (11-10) In touch, soon led, headed 2 out, no impression on winner run-in, kept on same pace, 2nd of 6, 5l behind Captain Guinness (11-3) at Naas 2m chs Grd 3 (1)
- 3 11-U11 **EDITEUR DU GITE** (95) (CD)
G L Moore 8 11-9 Joshua Moore 162 GS
3-1fav (11-2) Made most, jumped well, soon asserted and ridden out run-in, stayed on well, always doing enough, won at Chelt 2m hcp ch (2) gs bt Cheddleton (11-9) by 4l
- 4 5062F1 **A WAVE OF THE SEA** (39) (B) (D)
J P O'Brien (IRE) 6 11-6 S Fitzgerald (5) 159 S
9-2 (11-5) Mid-division, disputed lead straight and pushed along before last, kept on well under pressure, won at Leopardstown 2m 1f hcp ch bt Grange Walk (11-0) by 1½l
- 5 211326 **EXIT POLL** (39) (D)
J Harrington (IRE) 8 11-5 S O'Keeffe 157 S
9-2 (11-7) Led early, pushed along after 2 out and dropped to 5th before last, no extra, 6th of 9, 18l behind A Wave Of The Sea (11-5) at Leopardstown 2m 1f hcp ch in Feb
- 6 1-1142 **BEFORE MIDNIGHT** (47) (CD)
S Thomas 9 11-4S Twiston-Davies 164 G
7-2 (11-8) Pressed leader, ridden 3 out, headed before last, rallied to lead flat, headed close home, 2nd of 7, 1l bhd Funambule Sivola (11-12) at Donc 2m hcp chs (2) gd
- 7 121365 **EMBITTERED** (39) (D) (F)
J P O'Brien (IRE) 8 11-1 B J Cooper 155 S
80-1 (11-12) Rear, slow and detached, no impression in rear 2 out, no extra in straight, 5th of 6, 34l behind Blue Lord (11-12) at Leopardstown 2m 1f nov chs G1 (1) in Feb
- 8 222214 **BUDDY RICH** (109) (BF) (SF)
G Elliott (IRE) 9 11-0 D N Russell 158 G
5-2fav (11-0) Mid-division, travelling well 2 out, ridden before last, 4th inside final furlong, no extra, 4th of 10, 7l behind Dunvegan (11-1) at Fairyhouse 2m hcp ch gd
- 9 2-4211 **ELIXIR DE NUTZ** (33) (CD)
C Tizzard 8 10-13 Jonjo O'Neill Jr 160 G
2-1fav (11-8) Led 1st, drawing clear when not fluent 2 out, eased towards finish, won at Kempton 2m 2f nov Ltd hcp ch (3) gd in Feb bt Across The Line (10-10) by 13l
- 10 6412F1 **AMARILLO SKY** (24) (D)
C Tizzard 6 10-13 B J Powell 163 S
3-1 (11-10) Jumped boldly, tracked leading pair, led 4 out, clear next, stayed on strongly, won at Newbury 2m nov chs (2) sft bt Shakem Up'arry (11-12) by 10l

- 11 16/13F **DANCING ON MY OWN** (31)
H De Bromhead (IRE) 8 10-13 D J O'Keeffe 154 YS
14-1 (11-9) Rear of mid-division, slight mistake 3rd, 4th and no impression when fell last, in a race won by Ciel De Neige (11-12) at Punchestown 2m nov ch hvy in Feb
- 12 2-31P3 **IL RIDOTO** (52) (D)
P Nicholls 5 10-13 H Cobden 166 H
3-1 (11-4) Led, pushed along turning in, joined from next, headed and no extra run-in, lost 2nd closing stages, 3rd of 4, 4½l bhd War Lord (11-8) at Lin 2m nov chs (2) hvy
- 13 07-2U1 **THYME WHITE** (77) (D)
P Nicholls 6 10-12 Bryony Frost 159 S
85-40fav (11-8) Chased leaders, disputing 2nd from 7th, led going well next, clear flat, very easily, won at Donc 2m nov hcp ch (3) sft in Dec bt Nero Rock (11-1) by 5l
- 14 -43312 **FRERO BANBOU** (39) (D)
V Williams 7 10-11 C Deutsch 167 GS
5-2 (11-5) Held up in rear, steady headway 3 out, stayed on same pace run-in, no chance with winner, 2nd of 8, 4l behind Dolos (11-8) at Sand 1m 7f hcp chs (2) gs
- 15 2U1PU5 **POSEIDON** (31) (D)
C Byrnes (IRE) 8 10-11 D E Mullins 158 G
33-1 (11-9) Mid-division, no impression 4 out, left 5th at last, ridden and kept on one pace, 5th of 9, 24l behind Ciel De Neige (11-12) at Punchestown 2m nov ch hvy
- 16 03-482 **GUMBALL** (84) (D)
F O'Brien 8 10-10 P Brennan 165 GS
10-3 (11-12) Rear, pushed along & headway 3 out, strongly pressed leader 2 out, kept on but always held 2nd of 6, ½l bhd Not Available (11-1) at Lud 2m hcp chs (2) gs
- 17 69-1F8 **CAPUCCIMIX** (39) (D)
H De Bromhead (IRE) 9 10-8 J Gainford (3) 165 G
12-1 (11-5) Always towards rear, detached before 3 out, bad mistake 2 out, weakened, 8th of 9, 41l behind A Wave Of The Sea (11-5) at Leopardstown 2m 1f hcp ch in Feb
- 18 -F31F4 **FOR PLEASURE** (32) (CD)
A Hales 7 10-8 H Bannister 164 GS
25-1 (11-0) Raced freely, clear 3rd until 6th, not fluent 7th, headed after next, weakened 3 out, last of 4, 20l behind Edwardstone (11-5) at Warwick 2m nov chs G2 (1) gs
- 19 42U111 **HASANKEY** (28) (V) (D)
L Morgan 6 10-7 L Dobb (7) 160 S
3-1fav (11-0) Chased leaders, challenging when not fluent 4 out, led before last, driven flat, held on, won at Weth 1m 7f hcp chs (3) sft bt Destined To Shine (11-0) by hd
- 20 -92023 **GLOBAL CITIZEN** (39) (D)
B Pauling 10 10-6 K Woods --
14-1 (11-5) Pressed winner, led 2nd, pushed along and headed 2 out where mistake, no chance with winner, 3rd of 5, 16l behind Goshen (11-1) at Sand 2m Ltd hdl gs

BETTING: 6 Buddy Rich, 7 Embittered, 15-2 Amarillo Sky, 8 Thyme White, Andy Dufresne, 12 Frero Banbou, Editeur Du Gite, Dancing On My Own.
2021: SKY PIRATE 8 11 6, Nick Scholfield 14-1 (Jonjo O'Neill), 19 ran.

ONE FOR EVERYONE

£1 FREE BET TODAY
AT THE CHELTENHAM FESTIVAL

Available at Ladbrokes.com



Ladbrokes

TAKE TIME TO THINK™
taketimetothink.co.uk

BeGambleAware.org 18+

5.30 WEATHERBYS CHAMPION BUMPER

(GRADE 1) (1) (4-6yo) 2m Winner £45,560 (22 run) RTV

MAGIC MIKE CAN BEWITCH RIVALS



AMERICAN BEAUTY
American Mike has masses of potential

FREE

£2

SHOP BET

William HILL



MORE heroes will be made on the second day of the Cheltenham Festival and we've teamed up with William Hill to give you another £2 free bet to stake in their shops.

From today's seven races, all eyes will be on the Champion Chase (3.30pm) where we'll get a rematch between Shishkin and Energumene.

The pair faced off in the Clarence House Chase with Nicky Henderson's star winning by one length.

And when you throw Put The Kettle On - last year's winner - Chacun Pour Soi and Nube Negra into the mix, you've got a stellar cast. Tiger Roll could bow out after the Cross Country. He's a three-time winner of the race and all the talk from Gigginstown suggests this could be his final run.

Plus, Chelsea take on Lille in the Champions League, while there's Premier League football with Arsenal v Liverpool being the highlight.

HOW TO CLAIM Simply cut out the voucher and head to your nearest William Hill shop to stake your £2 free bet. It's valid for today only on any sport. 18+ only, see voucher for full terms and conditions.

FREE £2 BET

IN William HILL SHOPS

Valid until shop close on Wednesday March 16, 2022

To reader: Simply cut out this voucher and take it into any William Hill shop before close on Wednesday March 16, 2022 to claim your £2 Free Bet.

Terms and conditions: £2 Free Bet must be used over-the-counter on any sport in a William Hill before shop close on Wednesday March 16, 2022. One Free Bet per customer.

This Free Bet is non-transferable and cannot be redeemed for cash. If the Free Bet is partially redeemed, no change or additional Free Bets will be awarded. No payment will be made in respect of void bets. £2 Free Bet stake will not be included in any returns. Offer not valid for online or telephone betting. No photocopies accepted. Employees or agents of William Hill or Reach PLC, their family members or anyone else connected with the promotion may not use this Free Bet voucher. William Hill Fair Deal Rules apply. Over 18s only.

Promoter: William Hill Organization Limited, 1 Bedford Avenue, London WC1B 3AU. William Hill is licensed by the Gambling Commission. Reach is not licensed by the Gambling Commission and is not liable for any losses that arise out of this promotion including but not limited to attempted redemption of this voucher. For advice, visit begambleaware.org

TAKE TIME TO THINK

BeGambleAware.org

NEWSBOY'S 1-2-3

- 1 AMERICAN MIKE
- 2 FACILE VEGA
- 3 JAMES'S GATE

AMERICAN MIKE has won both his starts under Rules in impressive fashion - and has plenty more to offer.

Successful on his sole start in a point-to-point, at Cork last April, by 20 lengths, the son of Mahler went under the hammer for £195,000 at the

Tattersalls Cheltenham sales 13 days later.

Put into training with Gordon Elliott, American Mike was sent off at 4-7 for a bumper at Down Royal's Champion Chase undercard last October.

And he didn't disappoint his backers, cantering clear to beat Royal Romeo by seven lengths.

My selection's sights were then raised to Listed level at Navan a week before Christmas, and American Mike hardly came out of second gear to justify odds of 1-8 by 17 lengths from Battling

Bessie. The runner-up then gave the form a boost when going within a nose of victory in the Grade 2 mares' bumper at Leopardstown's Dublin Racing Festival last month. And Jamie Codd's mount has the untapped potential to move up to the top level and stay unbeaten.

Willie Mullins, throws no fewer than seven darts at the board in his quest for a 12th victory in this race, with Facile Vega, Redemption Bay and James's Gate the trio who appeal most of all in an intriguing contest.

	1 AIN'T NO SUNSHINE (26) (D) K Dalgleish 6 11-5 D McMenamin 112 H 5-4fav (11-5) Tracked leader, led 4f out, ridden and strongly pressed 3f out, won at Kelso 2m NH flat (4) hvy in Feb beating Eloi Du Puy (10-2) by 1, 7 ran
	1-11 AMERICAN MIKE (88) (D) (F) G Elliott (IRE) 5 11-5 Mr J Codd 135 GY 1-8fav (11-13) Tracked leader in 2nd, travelling well 2f out, stayed on strongly final furlong, impressive, won at Navan 2m Lstd nh flat bt Battling Bessie (11-6) by 17l
	2214 AUTHORISED SPEED (32) (BF, D) G L Moore 5 11-5 Joshua Moore 122 GS 13-8fav (11-5) Chased leaders, headway out 3f out, ridden over 2f out, unable to quicken, 4th of 12, 4l behind Top Dog (11-5) at Newbury 2m Listed NH flat (1) gs
	11 CALL ME HARRY (43) (D) I Jardine 5 11-5 C O'Farrell 113 SS 5-2 (11-9) Mid-division, headway tracking leaders 3f out, ridden to lead final furlong, stayed on well, won at Newc 2m NH flat (5) std bt Ri Na Farrage (11-9) by 1½l
	22 CILLIANS CHARM (30) A McCann (IRE) 5 11-5 Jonathan Moore 113 S 5-1 (11-2) Led, ridden and headed over 1f out, kept on one pace, 2nd of 11, 5l behind You Wear It Well (10-9) at Catterick 2m NH flat (5) sft in Feb
	2814 ESPERTI (154) (D) Peter Fahey (IRE) 5 11-5 K Sexton 114 GY 13-8 (11-9) Tracked leader, pace quickened 4f out, last 1½f out, no impression final furlong, last of 4, 4½l behind Hey Johnny (11-2) at Punchestown 2m 4yo NH flat gd
	11 FACILE VEGA (39) (D) (SF) W P Mullins (IRE) 5 11-5 Mr P W Mullins 139 Y 8-1fav (11-1) Tracked leaders, travelling well to lead 2f out, asserted and 5 lengths clear 1f out, very easily, won at Leap 2m G2 NH flat bt Sandor Clegane (11-1) by 12l
	37 GODOT (33) A Irvine 5 11-5 B J Powell 106 H 12-1 (11-5) Held up rear, headway 5f out, no impression, outpaced and well held over 2f out, 7th of 13, 28l behind Leave Of Absence (11-5) at Kempton 2m NH flat (5) gs
	11 HOULANBATORDECHAIS (136) (D) W P Mullins (IRE) 5 11-5 Rachael Blackmore 133 S 10-3 Made all, ran on strongly from 2f out, easily, won at Durtal (FR) 1m 6f NH flat sft in Oct, 7 ran
	1 JAMES'S GATE (31) (D) W P Mullins (IRE) 5 11-5 S O'Keefe 119 H 2-5fav (12-0) Led, joined after 5f, led again 6f out, travelled well entering straight and 3 lengths clear over 1f out, drew clear inside final furlong, very easily, won at Punchestown 2m NH flat hvy in Feb beating Secret Artist (11-7) by 8l, 12 ran
	F21 JOYEUX MACHIN (53) (D) P Nolan (IRE) 5 11-5 B J Cooper 121 S 13-8fav (12-2) Tracked leaders, pushed along ridden in 2nd 1f out, led final furlong, stayed on well, won at Navan 2m NH flat in Jan beating Don Chantal (12-2) by 1¾l
	11 MADMANSGAME (22) (D) W P Mullins (IRE) 5 11-5 D E Mullins 119 H 4-1fav (12-0) Made all, ridden over 1f out, strongly pressed inside final furlong, stayed on well close home, won at Navan 2m NH flat hvy in Feb bt Landrake (12-0) by ¾l
	F-121 MUSIC DRIVE (17) G Elliott (IRE) 5 11-5 D N Russell 121 S 9-2 (11-7) Disputed lead, pushed along to challenge 2f out, ridden and led 150 yards out, kept on well, won at Naas 1m 7f NH flat sft bt Sandor Clegane (11-1) by ¾l
	23 OCEAN OF MERCY (144) P Hennessy (IRE) 6 11-5 S Twiston-Davies 115 G 8-1 (11-0) Mid-division, headway over 3f out, driven over 1f out, kept on, went 3rd close home, 3rd of 15, 1l behind Bontay (10-10) at Cheltenham 2m NH flat (2) gd
	22-11 OUR JESTER (52) (D) H Morrison 6 11-5 N De Boinville 121 G 5-2 (11-8) Tracked leader, led entering final 4f, quickened pace and went clear 2f out, in no danger after, won at Lingfield 2m NH flat (2) std bt Swapped (11-8) by 3½l
	1 REDEMPTION DAY (78) (D) W P Mullins (IRE) 5 11-5 P Townend 124 S 8-1fav (12-2) Tracked leader, travelled well to lead 1½f out, asserted under 1f out, kept on well, easily, won at Leap 2m NH flat sft in Dec bt Music Drive (11-9) by 4½l
	1 SEABANK BISTRO (45) W P Mullins (IRE) 5 11-5 B Hayes 123 Y 5-4 (12-2) Mid-division, headway into 3rd straight, led travelling well 2f out, stayed on well under pressure, won at Naas 2m 3f NH flat bt Santonito (12-2) by 5l
	52-431 SPANISH PRESENT (22) M Keighley 6 11-5 S Bowen 112 S 15-8fav (11-2) Tracked leader, led 3f out, ridden clear over 1f out, won at Market Rasen 2m 1f NH flat (5) hvy in Feb beating Shantou's Melody (11-9) by 4l, 7 ran
	2-231 TOP DOG (32) (D) E Lavelle 5 11-5 T Bellamy 124 GS 9-1 (11-5) Raced keenly tracking leader, led and hung badly left final 2f, stayed on well, won at Newbury 2m Listed NH flat (1) gs in Feb beating Rosy Redrum (10-0) by 1½l
	4-1 VIVA DEVITO (97) (H) (D) W P Mullins (IRE) 5 11-5 Mr D O'Connor 115 S 5-6fav (11-11) Tracked leaders, headway to lead 5f out, went well clear, eased final furlong, very easily, won at Tramore 2m Ldy NH flat sft bt Bugs Moran (11-11) by 16l
	111 POETIC MUSIC (74) (C) O'Brien 4 10-2 P Brennan 124 S 7-2fav (10-5) Held up in rear, went 2nd 2f out, stayed on well final furlong, led towards finish, won at Chelt 1m 6f 4yo NH flat (Lstd) (1) sft bt Illade Allen (10-5) by 1½l
	12 ROSY REDRUM (32) (H) M Harris 4 10-2 M Bastyan 123 GS 7-1 (10-0) In rear, headway 2f out, shaken up and hung left 2f out, stayed on same pace final furlong, 2nd of 12, 1½l behind Top Dog (11-5) at Newb 2m Lstd NH flat gs

BETTING: 5-4 Facile Vega, 5-2 American Mike, 11-2 Redemption Day, 12 James's Gate, 20 Our Jester, Madmansgame, Houlanbatordechais, 25 Rosy Redrum, Seabank Bistro.
202: SIR GERHARD 6 11 5, Rachael Blackmore 85-40 (W P Mullins), 14 ran.



NEWCASTLE SKY SPORTS RACING.

Table with columns: GARRY OWEN, PA. Race numbers and names.

GOING: Standard. COURSE: Left-handed all-weather Tapeta course with a 3f run-in.

5.14 PLAY 4 TO WIN AT BETWAY HANDICAP (6)

Table with columns: Winner £2,970 (8 run), 1m 2f 49yds.

1 (6) 64-614 LOPES DANCER (15) H Bethell 10-9-12 (CD) ... Joanna Mason (3) 67

5.45 BETWAY HANDICAP (4)

Table with columns: Winner £4,995 (6 run), 1m 2f 42yds.

1 (4) 2411-2 PALLAS DANCER (13) P B Ellison 5-9-12 (CD) B Robinson 82

6.15 ALL WEATHER CHAMPIONSHIPS MILE HANDICAP (3)

Table with columns: Winner £8,480 (6 run), 1m 5yds.

1 (6) 70-122 DIDEROT (31) (H) J Ferguson 4 10-0 (D) ... D Muscutt 96

7.15 PLAY CORAL RACING-SUPER-SERIES FOR FREE

Table with columns: HANDICAP (5) (3-YO) Winner £3,510 (8 run), 7f 14yds.

1 (8) 31473- LIAMARTY DREAMS (152) K Burke 9-8 (CD) ... C Lee 76

7.45 READ KATIE WALSH ON BETWAY INSIDER HANDICAP (6)

Table with columns: Winner £2,970 (9 run), 6f.

1 (8) 431114 MILLION REASONS (12) (V) P Evans 4-9-7 (BFCD) ... D Keenan 60

6.45 AWC MILE MEDIAN AUCTION MAIDEN STAKES (6) Winner £2,754 (7 run) ... GRORYELLA (20) (B) B Rothwell 6-9-9 ... HELLAVAHEART (19) P Evans 3-8-11 ... OUTSMART (146) O Pears 3-8-11 ... SPELLS AT DAWN Alex French 3-8-11 ... HIGH BORN EAGLE J O'Keefe 3-8-6 ... SAORLA (18) A Balding 3-8-6 ... WHEAL KITTY (31) B Smart 3-8-6

7.15 PLAY CORAL RACING-SUPER-SERIES FOR FREE

Table with columns: HANDICAP (5) (3-YO) Winner £3,510 (8 run), 7f 14yds.

1 (8) 31473- LIAMARTY DREAMS (152) K Burke 9-8 (CD) ... C Lee 76

11.45 UNIBET BETTING OPERATOR OF THE YEAR NOVICE STAKES (5) (3-YO) Winner £3,510 (13 run) 1m 2f 219yds ... DECIDUOUS (32) C Appleby 9-9 ... LOST OF LOVE (25) R Hughes 9-9 ... SEA GREY (67) A Balding 9-9 ... SURREY MIST (40) G Baker 9-7 ... CLIFFS OF FURY (33) T Kent 9-2 ... INNER LIGHT C Appleby 9-2 ... PLANXTY (25) J Gallagher 9-2 ... SAINT PETER (47) S Kirk 9-2 ... SALVATOR MUNDI (156) J & T Gosden 9-2 ... TRUE ACCOLADE C Appleby 9-2 ... KIKAHOBBSIE (25) Joe Puntling 9-2 ... GOLD BELT (18) M Bell 8-11 ... JALEA MOON (18) J Chapple-Hyam 8-11

KEMPTON RACING TV.

Table with columns: GARRY OWEN, PA. Race numbers and names.

GOING: Standard to Slow. DRAW: No advantage. TOP TRAINER: John & Thady Gosden 88-369 (23.8%), TOP JOCKEY: David Probert 86-847 (10.2%).

6.00 UNIBET BETTING OPERATOR OF THE YEAR NOVICE STAKES (5) (3-YO) Winner £3,510 (13 run) 1m 2f 219yds

1 (6) 1 DECIDUOUS (32) C Appleby 9-9 ... Harry Davies (7) ... LOST OF LOVE (25) R Hughes 9-9 ... David Egan (7) ... SEA GREY (67) A Balding 9-9 ... C Hutchinson (5) 82 ... SURREY MIST (40) G Baker 9-7 ... T Whelan ... CLIFFS OF FURY (33) T Kent 9-2 ... N Callan ... INNER LIGHT C Appleby 9-2 ... James Doyle ... PLANXTY (25) J Gallagher 9-2 ... L Morris ... SAINT PETER (47) S Kirk 9-2 ... L Keniry ... SALVATOR MUNDI (156) J & T Gosden 9-2 ... R Havlin ... TRUE ACCOLADE C Appleby 9-2 ... W Buick ... KIKAHOBBSIE (25) Joe Puntling 9-2 ... C Bishop ... GOLD BELT (18) M Bell 8-11 ... C Shepherd ... JALEA MOON (18) J Chapple-Hyam 8-11 ... R Tart

6.30 UNIBET SUPPORT SAFE GAMBLING MEDIAN AUCTION MAIDEN STAKES (GBB RACE) (5) Winner £3,780 (14 run) 1m

1 (5) INDIAN PEARL (H) P Leech 4 10-0 ... W Carson ... DWYFRAN (1013) S C Williams 5 9-9 ... M Ghiani ... IMAGEMAKER Dr J Scargill 4 9-9 ... J F Egan ... SAFE PASSAGE (18) (E, H) L Dace 4 9-9 ... R Tart ... ARWAAG (T) A Watson 3 8-11 ... Adam J McNamara ... DOUBLE DARE YOU (25) C Cox 3 8-11 ... L Keniry ... GUILIN (11) S P C Woods 3 8-11 (BF) ... James Doyle ... OXYGEN THIEF (28) C Banham 3 8-11 ... J Haynes ... PAOLO PANINI (11) T Ward 3 8-11 ... D Bryan ... STEVENSON M Channon 3 8-11 ... C Bishop ... HESPERANTHA (18) A Balding 3 8-6 ... D Probert ... LANFEAR (86) Seamus Mullins 3 8-6 ... L Morris ... ROCKADE (138) S Kirk 3 8-6 ... David Egan ... TWILIGHT STEEL A Murphy 3 8-6 ... C Shepherd

7.00 UNIBET 3 UNIBOOSTS A DAY HANDICAP (4)

1 (6) 88936 FANTASY BELIEVER (149) E Walker 5 9-7 (CD) ... R Kingscote 85 ... TRICOLORE (21) (P) M Botti 4 9-5 ... M Callan 83 ... SPIRIT OF THE BAY (182) C Cox 4 9-5 (CD) ... H Crouch 83 ... BRAINS (26) (B) J Osborne 6 9-5 (CD) ... S Osborne (3) 83 ... GRAIGNES (191) G Baker 6 9-5 ... T Whelan 83 ... ENOUGH ALREADY (49) H Spiller 6 9-4 (D) ... S Donohoe 82 ... SEVENTH KINGDOM (21) J Osborne 4 9-2 ... N Currie 80 ... PROCLAIMER (51) J Camacho 5 8-9 (CD) ... O McSweeney (5) 76 ... HANDEL (53) C Banham 4 8-11 ... J Haynes (5) 76 ... STATELY HOME (28) S Lycett 5 9-9 (D) ... Josephine Gordon 73 ... BUXTED TOO J Williams 4 8-6 (BF) ... David Egan 70

7.30 TRY OUR NEW PRICE BOOSTS AT UNIBET HANDICAP (3)

1 (4) 2-1392 MOHAREB (28) M Appleby 6 10-0 (D) ... T Ladd (3) 82 ... YAZAMAN (195) R Cowell 4 9-7 ... Rossa Ryan 85 ... LITTLE BOY BLUE (249) W G M Turner 7 9-7 (D) ... B Browne (7) 85 ... AROUSING (7) W Haggas 4 9-7 (CD) ... A Farragher (5) 85 ... COUNT OTTO (12) (B) A Perrett 7 9-6 (CD) ... J Haynes 84 ... SECRET HANDSHEIKH (157) (B) J Gallagher 4 9-2 (D) ... N Callan 80 ... PRINCE OF ABINGTON (153) (V) J Chapple-Hyam ... Peate (7) 80 ... TYGER BAY (21) (B, T) C Allen 5 9-0 (CD) ... S M Levey 78 ... GOOD HUMOR (27) (T) S C Williams 5 8-10 (C) ... C Shepherd 74 ... IDOAPOLOGISE (11) (T) S Lycett 5 8-9 (D) ... D Probert 73 ... PUERTO DE VEGA (12) (T) S C Williams 4 8-9 (BF) ... M Ghiani 73 ... BOBBY ON THE BEAT (13) P McEntee 4 8-6 (CD) ... Josephine Gordon 70

MOHAREB 9-2 (8-7, Theodore Ladd) Led early, racing in close 3rd after 1f, effort 2f out, edged right and pressing over 1f out, held inside final 100 yards, kept on, 2nd of 3, 1/2l behind Papa Stour (8-4) at Kempton 6f hcp 0-105 (2) pol in Feb 1m 13.67s. YAZAMAN 3-1 (9-5, R Havlin) Mid-division far side of group, pushed along halfway, headway chasing leaders over 1f out, weakened inside final furlong, 10th of 11, 7l behind Strike Red (9-5) at Newcastle 6f hcp (3) in Sep 1m 11.67s. LITTLE BOY BLUE 12-1 (10-0, L Morris) Settled just behind leaders, ridden 2f out, stayed on, 5th of 12, 4l behind Top Secret (9-1) at Ascot 7f hcp 0-85 (4) gd in Jul 1m 27.28s. AROUSING 3-1 (9-7, Harry Davies) Went right start and dwelt, in rear, closer over 3f out, headway on inner well over 2f out, ridden and every chance over 1f out, ran on well to lead inside final furlong and pulled away closing stages, won at Kempton 6f app hcp (0-85) (4yo+) (4) pol beating Many A Star (9-4) bet in Feb 1m 11.32s. COUNT OTTO 14-1 (9-7, Joey Haynes) In touch, pushed along over 1f out, ridden final furlong, never a factor, 7th of 8, 3l behind Jack's Point (9-4) at Lingfield 6f hcp (0-90) (3) pol 1m 10.05s. SECRET HANDSHEIKH 40-1 (8-5, Darragh Keenan) Led on near side rail until over 2f out, weakened quickly and soon behind, last of 12, 17l behind Spanish Star (9-1) at Goodwood 6f hcp 0-95 (3) set in Oct 1m 14.50s. PRINCE OF ABINGTON 12-1 (9-4, B A Curtis) Off the pace and always behind, 9th of 10, 13l behind N You Dare (9-5) at Chelmsford City 7f hcp 0-85 (4) pol in Oct 1m 23.42s. TYGER BAY 7-2 (9-5, S M Levey) Prominent, led 2f out, clear inside final furlong, edged right, ran on, won at Kempton 6f hcp 0-75 (5) pol in Feb beating Sir Gregory (8-1) by 1 3/4l, 11 ran 1m 12.95s. GOOD HUMOR 28-1 (9-2, Daniel Muscutt) Towards rear, pushed along and headway approaching final furlong, stayed on, 3rd of 9, 2 1/4l behind Legende D-art (8-6) at Chelmsford City 7f hcp 0-80 (4) pol in Feb 1m 25.73s. IDOAPOLOGISE 14-1 (9-3, Josephine Gordon) Pulled hard in mid-division, ridden inside final 2f, never on terms, 7th of 8, 4l behind Whittle Le Woods (9-8) at Southwell 6f hcp 0-80 (4) 1m 15.02s. PUERTO DE VEGA 2-1 (9-8, Marco Ghiani) In touch, pushed along 2f out, ridden and stayed on towards finish, not pace to challenge, 3rd of 8, 1 1/2l behind Jack's Point (9-4) at Lingfield 6f hcp (0-90) (3) pol 1m 10.05s. BOBBY ON THE BEAT 22-1 (9-7, Callum Shepherd) Mid-division, carried right over 2f out, kept on inside final furlong, 4th of 10, 1 1/4l behind Intervention (8-8) at Southwell 6f hcp 0-70 (5) 1m 17.40s.

8.00 UNIBET EXTRA PLACE OFFERS EVERY DAY HANDICAP (3)

1 (7) 151-31 AUTHOR'S DREAM (36) (V) W Knight 9 9-11 (CD) M Ghiani 88 2 (6) 1535-2 MILITARY TWO STEP (30) C & M Johnston 4 9-8 (D) J Fanning 88 3 (3) 684-32 JUST IN TIME (36) (P) A King 8 9-6 (C) D Probert 83 4 (5) 24-115 RESUMPTION (29) W Haggas 4 9-4 ... A Farragher (5) 84 5 (8) 2154-1 HIGH WELLS (V) F O'Brien 8 9-3 (CD) ... R Horny 80 6 (2) 2215-5 JUSTUS (67) (P) J Williams 4 9-0 ... R Kingscote 80 7 (4) 23223-3 RED ROYALIST (P) S Edmunds 8 9-0 ... J F Egan 77 8 (1) 82-412 CHASE THE DOLLAR (20) D Loughnane 4 9-0 (BF) ... Rossa Ryan 80

BETTING: 5-2 Resumption, 11-4 Chase The Dollar, 5 Just In Time, Author's Dream, 8 Military Two Step, 10 Red Royalist, 20 High Wells, 25 Justus. 2021: CLEONTE 8 9-9, Joshua Bryan (3) 6-1 (A Balding), drawn (3), 5 ran. AUTHOR'S DREAM 11-4 (9-8, Marco Ghiani) Raced wide keen, tracked leader, pushed along to lead over 2f out, ridden and pressed inside final furlong, ran on, won at Southwell 2m hcp 0-90 (3) in Feb beating Just In Time (9-4) by nk, 6 ran 3m 49.71s. MILITARY TWO STEP 7-1 (9-2, J Fanning) Dwelt close up in 4th, wide and headway to track winner halfway, pushed along 3f out, kept on one pace, 2nd of 4, 1l behind Zeeband (9-9) at Wolverhampton 2m hcp (2) in Feb 3m 42.06s. JUST IN TIME 12-4 (9-4, Hollie Doyle) Raced wide close up, headway over 2f out, chased winner over 1f out, ridden and every chance inside final furlong, ran on, 2nd of 6, nk behind Author's Dream (9-8) at Southwell 2m hcp (0-90) (3) in Feb 3m 49.71s. RESUMPTION 7-4 (9-1, Tom Marquand) Chased leader, ridden over 2f out, weakened 1f out, 5th of 6, 7l behind Sir Chauvelin (9-8) at Newcastle 1m 4f hcp 0-95 (3) in Feb 2m 52.40s. HIGH WELLS 18-1 (8-9, Kielan Woods) Tracked leaders, ridden and every chance when edged left over 1f out, kept on one pace, 4th of 8, 2 3/4l behind Apparate (9-4) at Doncaster 1m 6f hcp 105 (2) gd in Sep 20m 55.48s. JUSTUS 22-1 (8-8, T E Whelan) Soon led, pushed along and headed over 2f out, lost 2nd inside final furlong, ridden and weakened over 1f out, last of 5, 8l behind Moliwood (8-12) at Kempton 2m hcp (2) pol in Jan 3m 37.28s. RED ROYALIST 7-1 (10-0, Mr Ben Bromley) Switched left after start, held up in rear, headway on outside over 1f out, went 3rd inside final furlong, never going pace to reach leading duo, 3rd of 14, 5l behind Frankensteinia (9-0) at York 2m hcp 0-80 (4) gd in Sep 20m 00.20s. CHASE THE DOLLAR 11-9 (9-11, Rossa Ryan) Tracked leader, pushed along to lead 2f out, driven inside final furlong, headed close home, 2nd of 11, nk behind Maharashtra (8-7) at Southwell 1m 4f hcp 0-75 (5) in Feb 2m 36.62s.

8.30 UNIBET SUPPORT SAFE GAMBLING HANDICAP (4)

1 (1) 5-5111 DEMBE (7) B Johnson 4 9-10 (CD) ... Doubtful 78 2 (4) 1140-8 TWILIGHT HEIR (12) S Durack 4 9-7 ... S W Kelly 80 3 (2) 4080-8 ZHUI FENG (215) T Ward 9 9-7 (CD) ... R Kingscote 80 4 (9) 5150-9 SIR TITAN (5) A Carroll 8 9-6 (CD) ... David Egan 79 5 (10) 9800- ENCOURAGED (248) J Fanshawe 4 9-5 ... D Probert 78 6 (5) 214-93 FOLLOW YOUR HEART (41) (T) M Loughnane 4 9-3 (CD) ... A Farragher (5) 76 7 (3) 82-111 THAPA VC (21) M Rimell 4 9-3 (CD) ... G Rooke (3) 76 8 (8) 551/76 MAIN TARGET (217) K P De Foy 4 9-2 (D) ... J Mitchell 75 9 (12) 4557-1 SAYIFYOUWILL (21) A Perrett 4 9-2 (CD) ... R Hornby 75 10 (11) 54128- GAINFOLD (171) S Dow 4 9-1 (D) ... J Morris 74 11 (7) /8130- LOCKDOWN (168) (H, T) G Baker 4 9-1 (C) ... J Whelan 74 12 (13) 123/6- JOHNNY REB (426) R Teal 6 8-13 (CD) ... K Shoemart 72 13 (6) 314-11 GOT NO DOLLARS (27) (T) S C Williams 4 8-12 (CD) ... M Ghiani 71

BETTING: 4 Got No Dollars, 9-2 Dembe, 5 Thapa VC, Sayifyouwill, 10 Encouraged, Follow Your Heart, 14 Johnny Reb, 16 Others. 2021: LETHAL TALENT 4 9 6, Hollie Doyle 7-2 (J Chapple-Hyam), drawn (1), 10 ran.



Advertisement for William Hill: NEW CUSTOMER OFFER AT CHELTHENHAM... BET GET £50 SIGN UP USING PROMO CODE PRESS50. Includes image of a jockey on a horse.